

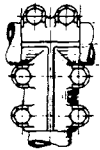

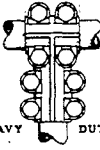
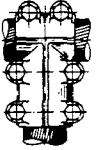
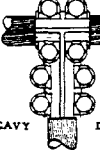
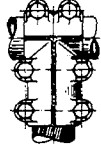
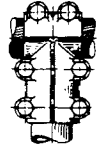
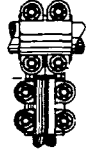
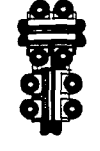
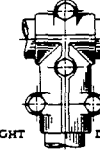
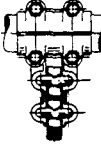
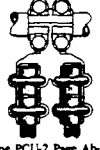
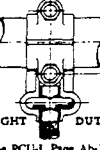
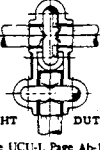
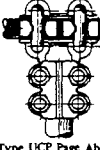

# POWER CONNECTORS

## TEE CONNECTORS PICTORIAL INDEX

### SECTION Ab.

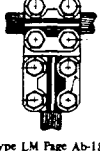
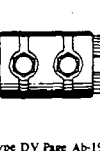
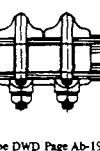
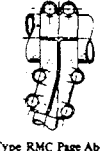
Ab-Tee Conn

	 HEAVY DUTY		 HEAVY DUTY	
Type RP Page Ab-1 & 2	Type RPH Page Ab-3	Type RC Page Ab-4 & 5	Type RCH Page Ab-6	Type RPC Page Ab-7 & 8
			 LIGHT DUTY	
Type RCP Page Ab-9 & 10	Type RTC Page Ab-11	Type RCC Page Ab-12	Type RP-L Page Ab-12	Type PCU Page Ab-13
	 LIGHT DUTY	 LIGHT DUTY		
Type PCU-2 Page Ab-14	Type PCU-L Page Ab-15	Type UCU-L Page Ab-15	Type UCP Page Ab-16	Type UCU Page Ab-17
				
Type LM Page Ab-18	Type DV Page Ab-19	Type DWD Page Ab-19	Type RMC Page Ab-20	Type RMV Page Ab-20

**ROYAL SWITCHGEAR MANUFACTURING CO.**

3995 Pine Lane SE • Bessemer, AL 35023 • (205) 426-4090 • FAX (205) 426-4095

# POWER CONNECTORS **Ab-1**

## TEE CONNECTOR TYPE RP

Ab-1 Tee Conn

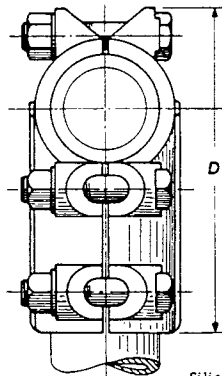
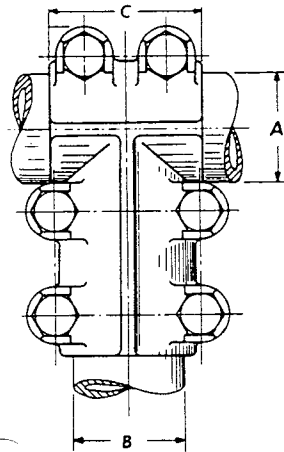

IPS Size		Cat. No.	Max. Dimensions in Inches			
Run	Tap		A	B	C	D
3/8	3/8	1070	.675	.675	2 7/16	4 3/8
1/2	3/8	1071	.840	.675	2 7/16	4 3/8
1/2	1/2	1072	.840	.840	2 7/16	4 3/8
3/4	3/8	1073	1.050	.675	2 7/16	4 3/8
3/4	1/2	1074	1.050	.840	2 7/16	4 3/8
3/4	3/4	1075	1.050	1.050	2 7/16	4 3/8
1	1/2	1076	1.315	.840	2 7/16	4 3/8
1	3/4	1077	1.315	1.050	2 7/16	4 3/8
1	1	1078	1.315	1.315	2 7/16	4 3/8
1 1/4	1/2	1079	1.660	.840	2 1/2	5
1 1/4	3/4	1080	1.660	1.050	2 1/2	5
1 1/4	1	1081	1.660	1.315	2 1/2	5
1 1/4	1 1/4	1082	1.660	1.660	2 1/2	5
1 1/2	1/2	1083	1.900	.840	2 3/4	5 7/8
1 1/2	3/4	1084	1.900	1.050	2 3/4	5 7/8
1 1/2	1	1085	1.900	1.315	2 3/4	5 7/8
1 1/2	1 1/4	1086	1.900	1.660	2 3/4	5 7/8
1 1/2	1 1/2	1087	1.900	1.900	2 3/4	5 7/8
2	1/2	1088	2.375	.840	3	6 3/4
2	3/4	1089	2.375	1.050	3	6 3/4
2	1	1090	2.375	1.315	3	6 3/4
2	1 1/4	1091	2.375	1.660	3	6 3/4
2	1 1/2	1092	2.375	1.900	3	6 3/4
2	2	1093	2.375	2.375	3	6 3/4
2 1/2	1/2	1094	2.875	.840	3 1/2	8
2 1/2	3/4	1095	2.875	1.050	3 1/2	8
2 1/2	1	1096	2.875	1.315	3 1/2	8
2 1/2	1 1/4	1097	2.875	1.660	3 1/2	8
2 1/2	1 1/2	1098	2.875	1.900	3 1/2	8
2 1/2	2	1099	2.875	2.375	3 1/2	8
2 1/2	2 1/2	1100	2.875	2.875	3 1/2	8
3	1/2	1101	3.500	.840	4	9
3	3/4	1102	3.500	1.050	4	9
3	1	1103	3.500	1.315	4	9
3	1 1/4	1104	3.500	1.660	4	9
3	1 1/2	1105	3.500	1.900	4	9
3	2	1106	3.500	2.375	4	9
3	2 1/2	1107	3.500	2.875	4	9
3	3	1108	3.500	3.500	4	9
3 1/2	3/4	1000	4.000	1.050	4	10
3 1/2	1	1001	4.000	1.315	4	10
3 1/2	1 1/4	1002	4.000	1.660	4	10
3 1/2	1 1/2	1003	4.000	1.900	4	10
3 1/2	2	1004	4.000	2.375	4	10
3 1/2	2 1/2	1005	4.000	2.875	4	10
3 1/2	3	1006	4.000	3.500	4	10
3 1/2	3 1/2	1007	4.000	4.000	4	10
4	3/4	1008	4.500	1.050	5 3/8	11 1/2
4	1	1009	4.500	1.315	5 3/8	11 1/2
4	1 1/4	1010	4.500	1.660	5 3/8	11 1/2
4	1 1/2	1011	4.500	1.900	5 3/8	11 1/2
4	2	1012	4.500	2.375	5 3/8	11 1/2
4	2 1/2	1013	4.500	2.875	5 3/8	11 1/2
4	3	1014	4.500	3.500	5 3/8	11 1/2
4	3 1/2	1015	4.500	4.000	5 3/8	11 1/2
4	4	1016	4.500	4.500	5 3/8	11 1/2

Example for ordering: - #1088 Royal Type RP Tee Connectors 2" IPS run - 1/2" IPS Tap.

Silicon Bronze bolts, nuts and lockwashers are standard.

Bolt heads are nested between ears on the casting which prevents the bolt head from turning, and permits one wrench installation.

Certified dimension prints will be furnished on request.

Special or unlisted sizes readily furnished.

NOTE: 1/2" bolts are furnished as STANDARD for 1/2" IPS tubing and larger, and 500 MCM cable and larger.

NOTE: This connector will meet or exceed NEMA requirements for Class CF-1; Pub. SG-1.

### ROYAL SWITCHGEAR MANUFACTURING CO.

3995 Pine Lane SE • Bessemer, AL 35023 • (205) 426-4090 • FAX (205) 426-4095

# Ab-2 POWER CONNECTORS

## TEE CONNECTOR TYPE RP

IPS Size		Cat. No.	Max. Dimensions in Inches			
Run	Tap		A	B	C	D
3/8	1/2	6393	.675	.840	2 7/16	4 3/8
3/8	3/4	6394	.675	1.050	2 7/16	4 3/8
1/2	1	6396	.840	1.315	2 7/16	4 3/8
3/4	1	6397	1.050	1.315	2 7/16	4 3/8
1/2	1 1/4	6398	.840	1.660	2 7/16	4 3/8
3/4	1 1/4	6399	1.050	1.660	2 7/16	4 3/8
1	1 1/4	6400	1.315	1.660	2 7/16	4 3/8
1/2	1 1/2	6401	.840	1.900	2 3/4	5 7/8
3/4	1 1/2	6402	1.050	1.900	2 3/4	5 7/8
1	1 1/2	6403	1.315	1.900	2 3/4	5 7/8
1 1/4	1 1/2	6404	1.660	1.900	2 3/4	5 7/8
1/2	2	6405	.840	2.375	2 3/4	5 7/8
3/4	2	6406	1.050	2.375	2 3/4	5 7/8
1	2	6407	1.315	2.375	2 3/4	5 7/8
1 1/4	2	6408	1.660	2.375	2 3/4	5 7/8
1 1/2	2	6409	1.900	2.375	2 3/4	5 7/8
1/2	2 1/2	6410	.840	2.875	3	6 3/4
3/4	2 1/2	6411	1.050	2.875	3	6 3/4
1	2 1/2	6412	1.315	2.875	3	6 3/4
1 1/4	2 1/2	6413	1.660	2.875	3	6 3/4
1 1/2	2 1/2	6414	1.900	2.875	3	6 3/4
2	2 1/2	6415	2.375	2.875	3	6 3/4
1/2	3	6416	.840	3.500	3 1/2	8
3/4	3	6417	1.050	3.500	3 1/2	8
1	3	6418	1.315	3.500	3 1/2	8
1 1/4	3	6419	1.660	3.500	3 1/2	8
1 1/2	3	6420	1.900	3.500	3 1/2	8
2	3	6421	2.375	3.500	3 1/2	8
2 1/2	3	6422	2.875	3.500	3 1/2	8
3/4	3 1/2	1017	1.050	4.000	4	9
1	3 1/2	1018	1.315	4.000	4	9
1 1/4	3 1/2	1019	1.660	4.000	4	9
1 1/2	3 1/2	1020	1.900	4.000	4	9
2	3 1/2	1021	2.375	4.000	4	9
2 1/2	3 1/2	1022	2.875	4.000	4	9
3	3 1/2	1023	3.500	4.000	4	9
3/4	4	1024	1.050	4.5000	5 3/8	10
1	4	1025	1.315	4.5000	5 3/8	10
1 1/4	4	1026	1.660	4.5000	5 3/8	10
1 1/2	4	1027	1.900	4.5000	5 3/8	10
2	4	1028	2.375	4.5000	5 3/8	10
2 1/2	4	1029	2.875	4.5000	5 3/8	10
3	4	1030	3.500	4.5000	5 3/8	10
3 1/2	4	1031	4.000	4.5000	5 3/8	10

Example for ordering: - #6396 Royal Type RP Tee Connector 1/2" Run - 1" IPS Tap.

Silicon Bronze bolts, nuts and lockwashers are standard. Bolt heads are nested between ears on the casting which prevents the bolt head from turning, and permits one wrench installation.

Certified dimension prints will be furnished on request.

Special or unlisted sizes readily furnished.

NOTE: 1/2" bolts are furnished as STANDARD for 1/2" IPS tubing and larger, and 500 MCM cable and larger.

NOTE: This connector will meet or exceed NEMA requirements for Class CF-1; Pub. SG-1.

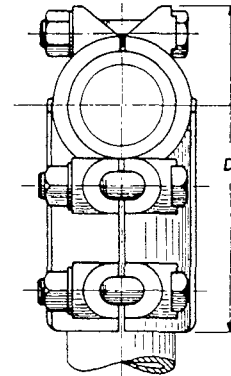
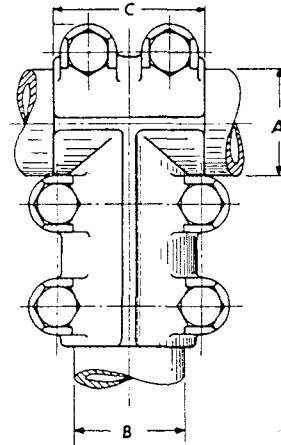

### ROYAL SWITCHGEAR MANUFACTURING CO.

3995 Pine Lane SE • Bessemer, AL 35023 • (205) 426-4090 • FAX (205) 426-4095

# POWER CONNECTORS **Ab-3**

## TEE CONNECTOR TYPE RPH

NEMA Class CF-2 - Heavy Duty

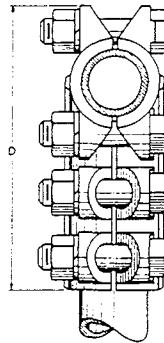
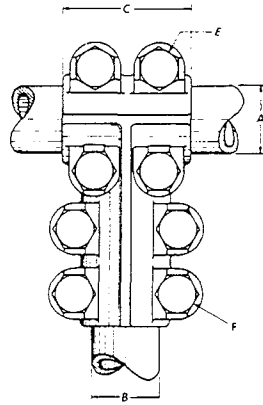

Cat. No.	IPS Size		Max. Dimensions in Inches					
	Run	Tap	A	B	C	D	E	F
15614	3/4	3/4	1.050	1.050	2 3/8	5 1/2	1/2	1/2
15615	1	3/4	1.315	1.050	2 3/8	5 1/2	1/2	1/2
15119	1	1	1.315	1.315	2 3/8	5 1/2	1/2	1/2
15616	1 1/4	3/4	1.660	1.050	2 3/8	5 3/4	1/2	1/2
15617	1 1/4	1	1.660	1.315	2 3/8	5 7/8	1/2	1/2
15618	1 1/4	1 1/4	1.660	1.660	2 1/2	6	1/2	1/2
15619	1 1/2	3/4	1.900	1.050	2 3/8	6	1/2	1/2
15121	1 1/2	1	1.900	1.315	2 3/8	6 1/8	1/2	1/2
15620	1 1/2	1 1/4	1.900	1.660	2 1/2	6 1/4	1/2	1/2
15120	1 1/2	1 1/2	1.900	1.900	2 3/4	6 1/2	1/2	1/2
15124	2	1	2.375	1.315	2 3/8	6 5/8	1/2	1/2
15621	2	1 1/4	2.375	1.660	2 1/2	6 3/4	1/2	1/2
15123	2	1 1/2	2.375	1.900	2 3/4	7	1/2	1/2
15122	2	2	2.375	2.375	3	7 1/4	1/2	1/2
15622	2 1/2	1	2.875	1.315	2 3/8	7	1/2	1/2
15623	2 1/2	1 1/4	2.875	1.660	2 1/2	7 1/8	1/2	1/2
15624	2 1/2	1 1/2	2.875	1.900	2 3/4	7 3/8	1/2	1/2
15625	2 1/2	2	2.875	2.375	3	7 5/8	1/2	1/2
15626	2 1/2	2 1/2	2.875	2.875	3 1/2	8 1/8	1/2	1/2
15627	3	1 1/4	3.500	1.660	2 1/2	8 1/4	5/8	1/2
15628	3	1 1/2	3.500	1.900	2 3/4	8 5/8	5/8	1/2
15629	3	2	3.500	2.375	3	8 7/8	5/8	1/2
15630	3	2 1/2	3.500	2.875	3 1/2	9 3/8	5/8	1/2
15631	3	3	3.500	3.500	4	9 7/8	5/8	5/8
15632	4	1 1/2	4.500	1.900	3	9 5/8	5/8	1/2
15633	4	2	4.500	2.375	3	9 7/8	5/8	1/2
15634	4	2 1/2	4.500	2.875	3 1/2	10 3/8	5/8	1/2
15635	4	3	4.500	3.500	4	10 7/8	5/8	5/8
15636	4	4	4.500	4.500	5	11 7/8	5/8	5/8

15637	3/4	1	1.050	1.315	2 3/8	5 1/2	1/2	1/2
15638	3/4	1 1/4	1.050	1.660	2 3/8	5 1/2	1/2	1/2
15639	1	1 1/4	1.315	1.660	2 3/8	5 1/2	1/2	1/2
15640	3/4	1 1/2	1.050	1.900	2 3/8	6	1/2	1/2
15641	1	1 1/2	1.315	1.900	2 3/8	6 1/8	1/2	1/2
15642	1 1/4	1 1/2	1.660	1.900	2 1/2	6 1/4	1/2	1/2
15643	1	2	1.315	2.375	2 3/8	6 5/8	1/2	1/2
15644	1 1/4	2	1.660	2.375	2 1/2	6 3/4	1/2	1/2
15645	1 1/2	2	1.900	2.375	2 1/2	7	1/2	1/2
15646	1	2 1/2	1.315	2.875	2 3/8	7	1/2	1/2
15647	1 1/4	2 1/2	1.660	2.875	2 1/2	7 1/8	1/2	1/2
15648	1 1/2	2 1/2	1.900	2.875	2 3/4	7 1/4	1/2	1/2
15649	2	2 1/2	2.375	2.875	3	7 5/8	1/2	1/2
15650	1 1/4	3	1.660	3.500	3	8	1/2	5/8
15651	1 1/2	3	1.900	3.500	3	8 1/4	1/2	5/8
15652	2	3	2.375	3.500	3	8 1/2	1/2	5/8
15653	2 1/2	3	2.875	3.500	3	8 3/4	1/2	5/8
15654	1 1/2	4	1.900	4.500	4	9 1/2	1/2	5/8
15655	2	4	2.375	4.500	4	9 3/4	1/2	5/8
15656	2 1/2	4	2.875	4.500	4	10 1/4	1/2	5/8
15657	3	4	3.500	4.500	4	10 3/4	5/8	5/8

Example for Ordering: - #15642 Royal Type RPH Tee Connector 1-1/4 IPS Run to 1-1/2 IPS Tap.

Silicon Bronze bolts, nuts and lockwashers are standard.

Bolt heads are nested between ears on the casting which prevents the bolt head from turning, and permits one wrench installation.

Certified dimension prints will be furnished on request.

Special or unlisted sizes readily furnished.

NOTE: 1/2" bolts are furnished as STANDARD for 1/2" IPS tubing and larger, and 500 MCM cable and larger.

Ab-Tee Conn

### ROYAL SWITCHGEAR MANUFACTURING CO.

3995 Pine Lane SE • Bessemer, AL 35023 • (205) 426-4090 • FAX (205) 426-4095

# Ab-4 POWER CONNECTORS

## TEE CONNECTOR TYPE RC

Size of Cable		Cat. No.	Max. Dimensions in Inches			
Main	Tap		A	B	C	D
6	6	1176	.186	.186	2	3 1/8
4	6	1177	.234	.186	2	3 1/8
4	4	1178	.234	.234	2	3 1/8
2	6	1179	.296	.186	2	3 1/8
2	4	1180	.296	.234	2	3 1/8
2	2	1181	.296	.296	2	3 1/8
1/0	6	1182	.374	.186	2	3 1/8
1/0	4	1183	.374	.234	2	3 1/8
1/0	2	1184	.374	.296	2	3 1/8
1/0	1/0	1185	.374	.374	2	3 1/8
2/0	6	1186	.420	.186	2	3 1/8
2/0	4	1187	.420	.234	2	3 1/8
2/0	2	1188	.420	.296	2	3 1/8
2/0	0	1189	.420	.374	2	3 1/8
2/0	2/0	1190	.420	.420	2	3 1/8
3/0	6	1191	.471	.186	2 1/2	4
3/0	4	1192	.471	.234	2 1/2	4
3/0	2	1193	.471	.296	2 1/2	4
3/0	0	1194	.471	.374	2 1/2	4
3/0	2/0	1195	.471	.420	2 1/2	4
3/0	3/0	1196	.471	.471	2 1/2	4
4/0	6	1197	.533	.186	2 1/2	4
4/0	4	1198	.533	.234	2 1/2	4
4/0	2	1199	.533	.296	2 1/2	4
4/0	0	1200	.533	.374	2 1/2	4
4/0	2/0	1201	.533	.420	2 1/2	4
4/0	3/0	1202	.533	.471	2 1/2	4
4/0	4/0	1203	.533	.533	2 1/2	4
250 MCM	4	1204	.576	.234	2 1/2	4
250 MCM	2	1205	.576	.296	2 1/2	4
250 MCM	1/0	1206	.576	.374	2 1/2	4
250 MCM	2/0	1207	.576	.420	2 1/2	4
250 MCM	3/0	1208	.576	.471	2 1/2	4
250 MCM	4/0	1209	.576	.533	2 1/2	4
250 MCM	250 MCM	1210	.576	.576	2 1/2	4
300 MCM	1/0	1211	.631	.374	2 1/2	4
300 MCM	2/0	1212	.631	.420	2 1/2	4
300 MCM	3/0	1213	.631	.471	2 1/2	4
300 MCM	4/0	1214	.631	.533	2 1/2	4
300 MCM	250 MCM	1215	.631	.576	2 1/2	4
300 MCM	300 MCM	1216	.631	.631	2 1/2	4
350 MCM	1/0	1217	.682	.374	2 1/2	4
350 MCM	2/0	1218	.682	.420	2 1/2	4
350 MCM	3/0	1219	.682	.471	2 1/2	4
350 MCM	4/0	1220	.682	.533	2 1/2	4
350 MCM	250 MCM	1221	.682	.576	2 1/2	4
350 MCM	300 MCM	1222	.682	.631	2 1/2	4
350 MCM	350 MCM	1223	.682	.682	2 1/2	4
500 MCM	1/0	1224	.815	.374	2 1/2	4
500 MCM	2/0	1225	.815	.420	2 1/2	4
500 MCM	3/0	1226	.815	.471	2 1/2	4
500 MCM	4/0	1227	.815	.533	2 1/2	4
500 MCM	250 MCM	1228	.815	.576	2 1/2	4
500 MCM	300 MCM	1229	.815	.631	2 1/2	4
500 MCM	350 MCM	1230	.815	.682	2 1/2	4
500 MCM	500 MCM	1231	.815	.815	2 1/2	4

Example for ordering: - #1203 Royal Type RC Tee Connectors 4/0 cable run - 4/0 Cable Tap.

Silicon Bronze bolts, nuts and lockwashers are standard.

Bolt heads are nested between ears on the casting which prevents the bolt head from turning, and permits one wrench installation.

Certified dimension prints will be furnished on request.

Special or unlisted sizes readily furnished.

NOTE: 1/2" bolts are furnished as STANDARD for 1/2" IPS tubing and larger, and 500 MCM cable and larger.

NOTE: This connector will meet or exceed NEMA requirements for Class CF-1; Pub. SG-1.

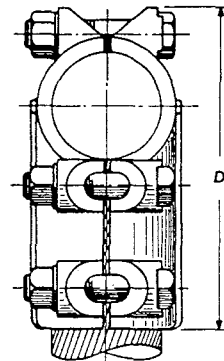
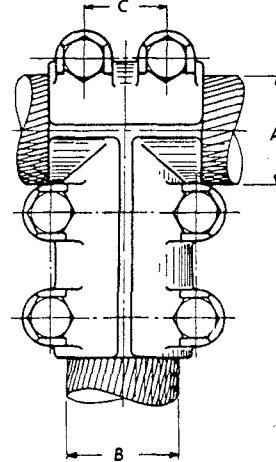

**ROYAL SWITCHGEAR MANUFACTURING CO.**

3995 Pine Lane SE • Bessemer, AL 35023 • (205) 426-4090 • FAX (205) 426-4095

# POWER CONNECTORS **Ab-5**

Ab-1 Tee Conn

## TEE CONNECTOR TYPE RC

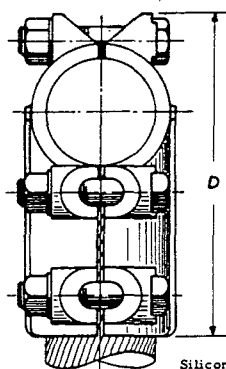
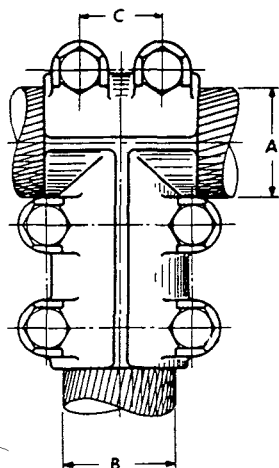

Size of Cable		Cat. No.	Max. Dimensions in Inches			
Main	Tap		A	B	C	D
750 MCM	0	1232	.999	.374	2 1/2	4 1/2
750 MCM	2/0	1233	.999	.420	2 1/2	4 1/2
750 MCM	3/0	1234	.999	.471	2 1/2	4 1/2
750 MCM	4/0	1235	.999	.533	2 1/2	4 1/2
750 MCM	250 MCM	1236	.999	.576	2 1/2	4 1/2
750 MCM	300 MCM	1237	.999	.631	2 1/2	4 1/2
750 MCM	350 MCM	1238	.999	.682	2 1/2	4 1/2
750 MCM	500 MCM	1239	.999	.815	2 1/2	4 1/2
750 MCM	750 MCM	1240	.999	.999	2 1/2	4 1/2
1000 MCM	1/0	1241	1.153	.374	2 1/2	4 1/2
1000 MCM	2/0	1242	1.153	.420	2 1/2	4 1/2
1000 MCM	3/0	1243	1.153	.471	2 1/2	4 1/2
1000 MCM	4/0	1244	1.153	.533	2 1/2	4 1/2
1000 MCM	250 MCM	1245	1.153	.576	2 1/2	4 1/2
1000 MCM	300 MCM	1246	1.153	.631	2 1/2	4 1/2
1000 MCM	350 MCM	1247	1.153	.682	2 1/2	4 1/2
1000 MCM	500 MCM	1248	1.153	.815	2 1/2	4 1/2
1000 MCM	750 MCM	1249	1.153	.999	2 1/2	4 1/2
1000 MCM	1000 MCM	1250	1.153	1.153	2 1/2	4 1/2
1250 MCM	4/0	1370	1.289	.533	2 1/2	4 1/2
1250 MCM	250 MCM	1371	1.289	.576	2 1/2	4 1/2
1250 MCM	300 MCM	1372	1.289	.631	2 1/2	4 1/2
1250 MCM	500 MCM	1373	1.289	.815	2 1/2	4 1/2
1250 MCM	750 MCM	1374	1.289	.999	2 1/2	4 1/2
1250 MCM	1000 MCM	1375	1.289	1.153	2 1/2	4 1/2
1250 MCM	1250 MCM	1376	1.289	1.289	2 1/2	4 1/2
1500 MCM	4/0	1377	1.412	.533	2 3/4	5 1/8
1500 MCM	250 MCM	1378	1.412	.576	2 3/4	5 1/8
1500 MCM	350 MCM	1379	1.412	.682	2 3/4	5 1/8
1500 MCM	500 MCM	1380	1.412	.815	2 3/4	5 1/8
1500 MCM	750 MCM	1381	1.412	.999	2 3/4	5 1/8
1500 MCM	1000 MCM	1382	1.412	1.152	2 3/4	5 1/8
1500 MCM	1250 MCM	1383	1.412	1.289	2 3/4	5 1/8
1500 MCM	1500 MCM	1384	1.412	1.412	2 3/4	5 1/8
1750 MCM	4/0	1385	1.526	.533	2 3/4	5 1/8
1750 MCM	250 MCM	1386	1.526	.576	2 3/4	5 1/8
1750 MCM	350 MCM	1387	1.526	.682	2 3/4	5 1/8
1750 MCM	500 MCM	1388	1.526	.815	2 3/4	5 1/8
1750 MCM	750 MCM	1389	1.526	.999	2 3/4	5 1/8
1750 MCM	1000 MCM	1390	1.526	1.152	2 3/4	5 1/8
1750 MCM	1250 MCM	1391	1.526	1.289	2 3/4	5 1/8
1750 MCM	1500 MCM	1392	1.526	1.422	2 3/4	5 1/8
1750 MCM	1750 MCM	1393	1.526	1.526	2 3/4	5 1/8
2000 MCM	4/0	1394	1.632	.533	2 3/4	5 1/8
2000 MCM	250 MCM	1395	1.632	.576	2 3/4	5 1/8
2000 MCM	350 MCM	1396	1.632	.682	2 3/4	5 1/8
2000 MCM	500 MCM	1398	1.632	.815	2 3/4	5 1/8
2000 MCM	750 MCM	1399	1.632	.999	2 3/4	5 1/8
2000 MCM	1000 MCM	1400	1.632	1.152	2 3/4	5 1/8
2000 MCM	1250 MCM	1401	1.632	1.289	2 3/4	5 1/8
2000 MCM	1500 MCM	1402	1.632	1.412	2 3/4	5 1/8
2000 MCM	1750 MCM	1403	1.632	1.526	2 3/4	5 1/8
2000 MCM	2000 MCM	1404	1.632	1.632	2 3/4	5 1/8

Example for ordering: - #1388 Royal Type RC Tee Connectors 1750 MCM Run - 750 MCM Tap.

Silicon Bronze bolts, nuts and lockwashers are standard.

Bolt heads are nested between ears on the casting which prevents the bolt head from turning, and permits one wrench installation.

Certified dimension prints will be furnished on request.

Special or unlisted sizes readily furnished.

NOTE: 1/2" bolts are furnished as STANDARD for 1/2" IPS tubing and larger, and 500 MCM cable and larger.

NOTE: This connector will meet or exceed NEMA requirements for Class CF-1; Pub. SG-1.

## ROYAL SWITCHGEAR MANUFACTURING CO.

3995 Pine Lane SE • Bessemer, AL 35023 • (205) 426-4090 • FAX (205) 426-4095

# Ab-6 POWER CONNECTORS

## TEE CONNECTOR TYPE RCH

NEMA Class CF-2 - Heavy Duty

Cat. No.	Cable Size		Max. Dimensions in Inches					
	Run	Tap	A	B	C	D	E	F
15658	500 MCM	500 MCM	.815	.815	2 1/2	4 7/8	1/2	1/2
15659	750 MCM	500 MCM	.999	.815	2 1/2	4 7/8	1/2	1/2
15660	750 MCM	750 MCM	.999	.999	2 1/2	4 7/8	1/2	1/2
15661	1000 MCM	500 MCM	1.153	.815	2 1/2	4 7/8	1/2	1/2
15662	1000 MCM	750 MCM	1.153	.999	2 1/2	4 7/8	1/2	1/2
15663	1000 MCM	1000 MCM	1.153	1.153	2 1/2	4 7/8	1/2	1/2
15664	1250 MCM	500 MCM	1.289	.815	2 1/2	4 7/8	1/2	1/2
15665	1250 MCM	750 MCM	1.289	.999	2 1/2	4 7/8	1/2	1/2
15666	1250 MCM	1000 MCM	1.289	1.153	2 1/2	4 7/8	1/2	1/2
15667	1250 MCM	1250 MCM	1.289	1.289	2 1/2	4 7/8	1/2	1/2
15668	1500 MCM	500 MCM	1.412	.815	2 3/4	5 1/2	1/2	1/2
15669	1500 MCM	750 MCM	1.412	.999	2 3/4	5 1/2	1/2	1/2
15670	1500 MCM	1000 MCM	1.412	1.153	2 3/4	5 1/2	1/2	1/2
15671	1500 MCM	1250 MCM	1.412	1.289	2 3/4	5 1/2	1/2	1/2
15672	1500 MCM	1500 MCM	1.412	1.412	2 3/4	5 1/2	1/2	1/2
15673	1750 MCM	500 MCM	1.526	.815	2 3/4	5 1/2	1/2	1/2
15674	1750 MCM	750 MCM	1.526	.999	2 3/4	5 1/2	1/2	1/2
15675	1750 MCM	1000 MCM	1.526	1.153	2 3/4	5 1/2	1/2	1/2
15676	1750 MCM	1250 MCM	1.526	1.289	2 3/4	5 1/2	1/2	1/2
15677	1750 MCM	1500 MCM	1.526	1.412	2 3/4	5 1/2	1/2	1/2
15678	1750 MCM	1750 MCM	1.526	1.526	2 3/4	5 1/2	1/2	1/2
15679	2000 MCM	500 MCM	1.632	.815	2 3/4	5 1/2	1/2	1/2
15680	2000 MCM	750 MCM	1.632	.999	3	5 1/2	1/2	1/2
15681	2000 MCM	1000 MCM	1.632	1.153	3	5 1/2	1/2	1/2
15682	2000 MCM	1250 MCM	1.632	1.289	3	5 1/2	1/2	1/2
15683	2000 MCM	1500 MCM	1.632	1.412	3	5 1/2	1/2	1/2
15684	2000 MCM	1750 MCM	1.632	1.526	3	5 1/2	1/2	1/2
15685	2000 MCM	2000 MCM	1.632	1.632	3	5 1/2	1/2	1/2
15686	2500 MCM	750 MCM	1.823	.999	3	6 1/2	5/8	1/2
15687	2500 MCM	1000 MCM	1.823	1.153	3	6 1/2	5/8	1/2
17699	2500 MCM	1250 MCM	1.823	1.289	3	6 1/2	5/8	1/2
17700	2500 MCM	1500 MCM	1.823	1.412	3	6 1/2	5/8	1/2
17701	2500 MCM	1750 MCM	1.823	1.526	3	6 1/2	5/8	1/2
17702	2500 MCM	2000 MCM	1.823	1.623	3	6 1/2	5/8	1/2
17703	2500 MCM	2500 MCM	1.823	1.823	3	6 1/2	5/8	5/8
17704	3000 MCM	750 MCM	1.998	.999	3 1/2	6 1/2	5/8	1/2
17705	3000 MCM	1000 MCM	1.998	1.153	3 1/2	6 1/2	5/8	1/2
17706	3000 MCM	1250 MCM	1.998	1.289	3 1/2	6 1/2	5/8	1/2
17707	3000 MCM	1500 MCM	1.998	1.412	3 1/2	6 1/2	5/8	1/2
17708	3000 MCM	1750 MCM	1.998	1.526	3 1/2	6 1/2	5/8	1/2
17709	3000 MCM	2000 MCM	1.998	1.623	3 1/2	6 1/2	5/8	1/2
17710	3000 MCM	2500 MCM	1.998	1.823	3 1/2	6 1/2	5/8	5/8
17711	3000 MCM	3000 MCM	1.998	1.998	3 1/2	6 1/2	5/8	5/8

Example for Ordering: - #15679 Royal Type RCH Tee Connector - Heavy Duty - 2,000 MCM Run, 500 MCM Tap.

Silicon Bronze bolts, nuts and lockwashers are standard.

Bolt heads are nested between ears on the casting which prevents the bolt head from turning, and permits one wrench installation.

Certified dimension prints will be furnished on request.

Special or unlisted sizes readily furnished.

NOTE: 1/2" bolts are furnished as STANDARD for 1/2" IPS tubing and larger, and 500 MCM cable and larger.

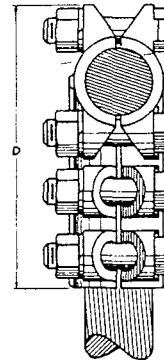
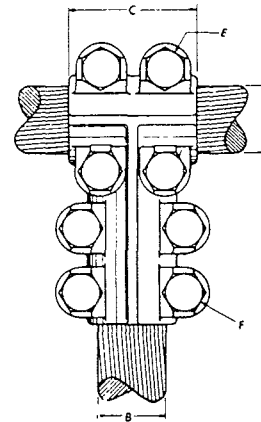

### ROYAL SWITCHGEAR MANUFACTURING CO.

3995 Pine Lane SE • Bessemer, AL 35023 • (205) 426-4090 • FAX (205) 426-4095

# POWER CONNECTORS Ab-7

## TEE CONNECTOR TYPE RPC

Ab-7 Tee Conn

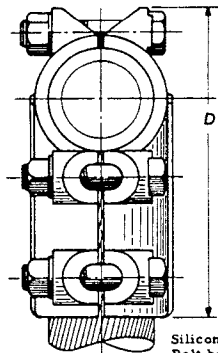
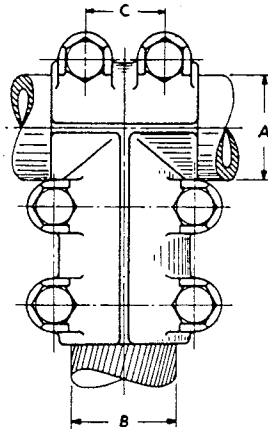

IPS Run	Cable Tap	Cat. No.	Max. Dimensions in Inches			
			A	B	C	D
1/2	1/0	1110	.840	.374	2 7/16	4 1/4
1/2	2/0	1111	.840	.420	2 7/16	4 1/4
1/2	3/0	1112	.840	.471	2 7/16	4 1/4
1/2	4/0	1113	.840	.533	2 7/16	4 1/4
1/2	250,000	1114	.840	.576	2 7/16	4 1/4
1/2	300,000	1115	.840	.631	2 7/16	4 1/4
1/2	350,000	1116	.840	.682	2 7/16	4 1/4
3/4	1/0	1117	1.050	.374	2 7/16	4 1/4
3/4	2/0	1118	1.050	.420	2 7/16	4 1/4
3/4	3/0	1119	1.050	.471	2 7/16	4 1/4
3/4	4/0	1120	1.050	.533	2 7/16	4 1/4
3/4	250,000	1121	1.050	.576	2 7/16	4 1/4
3/4	300,000	1122	1.050	.631	2 7/16	4 1/4
3/4	350,000	1123	1.050	.682	2 7/16	4 1/4
3/4	500,000	1124	1.050	.815	2 7/16	4 1/4
1	1/0	1125	1.315	.374	2 7/16	4 1/4
1	2/0	1126	1.315	.420	2 7/16	4 1/4
1	3/0	1127	1.315	.471	2 7/16	4 1/4
1	4/0	1128	1.315	.533	2 7/16	4 1/4
1	250,000	1129	1.315	.576	2 7/16	4 1/4
1	300,000	1130	1.315	.631	2 7/16	4 1/4
1	350,000	1131	1.315	.682	2 7/16	4 1/4
1	500,000	1132	1.315	.815	2 7/16	4 1/4
1	750,000	1133	1.315	.999	2 7/16	4 1/4
1 1/4	1/0	1134	1.660	.374	2 3/4	5 5/8
1 1/4	2/0	1135	1.660	.420	2 3/4	5 5/8
1 1/4	3/0	1136	1.660	.471	2 3/4	5 5/8
1 1/4	4/0	1137	1.660	.533	2 3/4	5 5/8
1 1/4	250,000	1138	1.660	.576	2 3/4	5 5/8
1 1/4	300,000	1139	1.660	.631	2 3/4	5 5/8
1 1/4	350,000	1140	1.660	.682	2 3/4	5 5/8
1 1/4	500,000	1141	1.660	.815	2 3/4	5 5/8
1 1/4	750,000	1142	1.660	.999	2 3/4	5 5/8
1 1/4	1,000,000	1143	1.660	1.153	2 3/4	5 5/8
1 1/4	1,250,000	1144	1.660	1.289	2 3/4	5 5/8
1 1/2	4/0	1145	1.900	.533	2 3/4	5 5/8
1 1/2	250,000	1146	1.900	.676	2 3/4	5 5/8
1 1/2	300,000	1147	1.900	.631	2 3/4	5 5/8
1 1/2	350,000	1148	1.900	.682	2 3/4	5 5/8
1 1/2	500,000	1149	1.900	.815	2 3/4	5 5/8
1 1/2	750,000	1150	1.900	.999	2 3/4	5 5/8
1 1/2	1,000,000	1151	1.900	1.153	2 3/4	5 5/8
1 1/2	1,250,000	1152	1.900	1.289	2 3/4	5 5/8
1 1/2	1,500,000	1153	1.900	1.413	2 3/4	5 5/8

Example for ordering: - #1125 Royal Type RPC Tee Connectors 1" IPS run - 1/0 cable tap.

Silicon Bronze bolts, nuts and lockwashers are standard.  
Bolt heads are nested between ears on the casting which prevents the bolt head from turning, and permits one wrench installation.

Certified dimension prints will be furnished on request.

Special or unlisted sizes readily furnished.

NOTE: 1/2" bolts are furnished as STANDARD for 1/2" IPS tubing and larger, and 500 MCM cable and larger.

NOTE: This connector will meet or exceed NEMA requirements for Class CF-1; Pub. SG-1.

**ROYAL SWITCHGEAR MANUFACTURING CO.**

3995 Pine Lane SE • Bessemer, AL 35023 • (205) 426-4090 • FAX (205) 426-4095



# Ab-8 POWER CONNECTORS

## TEE CONNECTOR TYPE RPC

IPS Run	Cable Tap	Cat. No.	Max. Dimensions in Inches			
			A	B	C	D
2	4/0	1154	2.375	.533	3	6 3/4
2	250,000	1155	2.375	.576	3	6 3/4
2	300,000	1156	2.375	.631	3	6 3/4
2	350,000	1157	2.375	.682	3	6 3/4
2	500,000	1158	2.375	.815	3	6 3/4
2	750,000	1159	2.375	.999	3	6 3/4
2	1,000,000	1160	2.375	1.153	3	6 3/4
2	1,250,000	1161	2.375	1.289	3	6 3/4
2	1,500,000	1162	2.375	1.413	3	6 3/4
2	1,750,000	1163	2.375	1.527	3	6 3/4
2	2,000,000	1164	2.375	1.632	3	6 3/4
2 1/2	4/0	1165	2.875	.533	3 1/2	7
2 1/2	250,000	1166	2.875	.576	3 1/2	7
2 1/2	300,000	1167	2.875	.631	3 1/2	7
2 1/2	350,000	1168	2.875	.682	3 1/2	7
2 1/2	500,000	1169	2.875	.815	3 1/2	7
2 1/2	750,000	1170	2.875	.999	3 1/2	7
2 1/2	1,000,000	1171	2.875	1.153	3 1/2	7
2 1/2	1,250,000	1172	2.875	1.289	3 1/2	7
2 1/2	1,500,000	1173	2.875	1.413	3 1/2	7
2 1/2	1,750,000	1174	2.875	1.527	3 1/2	7
2 1/2	2,000,000	1175	2.875	1.632	3 1/2	7
3	4/0	1032	3.500	.533	4	8
3	250,000	1033	3.500	.576	4	8
3	300,000	1034	3.500	.631	4	8
3	350,000	1035	3.500	.682	4	8
3	500,000	1036	3.500	.815	4	8
3	750,000	1037	3.500	.999	4	8
3	1,000,000	1038	3.500	1.153	4	8
3	1,250,000	1039	3.500	1.289	4	8
3	1,500,000	1040	3.500	1.413	4	8
3	1,750,000	1041	3.500	1.527	4	8
3	2,000,000	1042	3.500	1.632	4	8
3 1/2	4/0	1043	4.000	.533	4	9
3 1/2	250,000	1044	4.000	.576	4	9
3 1/2	300,000	1045	4.000	.631	4	9
3 1/2	350,000	1046	4.000	.682	4	9
3 1/2	500,000	1047	4.000	.815	4	9
3 1/2	750,000	1048	4.000	.999	4	9
3 1/2	1,000,000	1049	4.000	1.153	4	9
3 1/2	1,250,000	1050	4.000	1.289	4	9
3 1/2	1,500,000	1051	4.000	1.413	4	9
3 1/2	1,750,000	1052	4.000	1.527	4	9
3 1/2	2,000,000	1053	4.000	1.632	4	9
4	4/0	1054	4.500	.533	5 3/8	9
4	250,000	1055	4.500	.576	5 3/8	9
4	300,000	1056	4.500	.631	5 3/8	9
4	350,000	1057	4.500	.682	5 3/8	9
4	500,000	1058	4.500	.815	5 3/8	9
4	750,000	1059	4.500	.999	5 3/8	9
4	1,000,000	1060	4.500	1.153	5 3/8	9
4	1,250,000	1061	4.500	1.289	5 3/8	9
4	1,500,000	1062	4.500	1.413	5 3/8	9
4	1,750,000	1063	4.500	1.527	5 3/8	9
4	2,000,000	1064	4.500	1.632	5 3/8	9

Example for ordering: - #1043 Royal Type RPC Tee Connectors 3 1-2" IPS Run - 4/0 cable tap.

Silicon Bronze bolts, nuts and lockwashers are standard.

Bolt heads are nested between ears on the casting which prevents the bolt head from turning, and permits one wrench installation.

Certified dimension prints will be furnished on request.

Special or unlisted sizes readily furnished.

NOTE: 1/2" bolts are furnished as STANDARD for 1/2" IPS tubing and larger, and 500 MCM cable and larger.

NOTE: This connector will meet or exceed NEMA requirements for Class CF-1; Pub. SG-1.

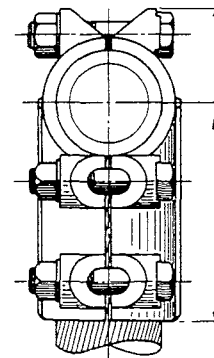
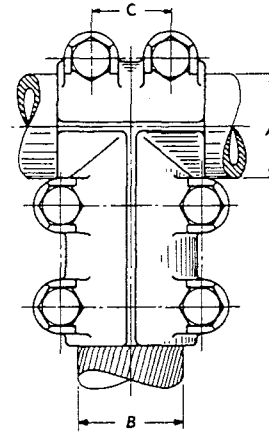

### ROYAL SWITCHGEAR MANUFACTURING CO.

3995 Pine Lane SE • Bessemer, AL 35023 • (205) 426-4090 • FAX (205) 426-4095

# POWER CONNECTORS Ab-9

Ab-9 Tee Conn

## TEE CONNECTOR TYPE RCP

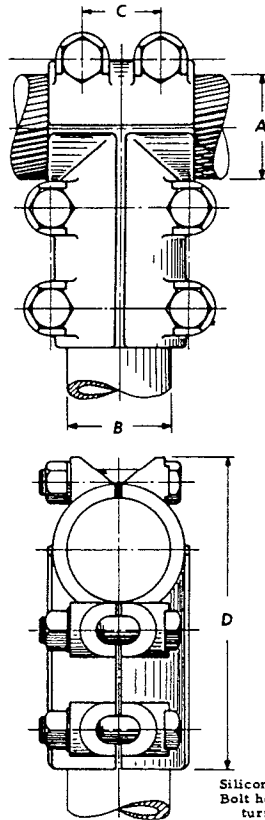

Cable Run	IPS Tap	Cat. No.	Max. Dimensions in Inches			
			A	B	C	D
1/0	1/2	6226	.374	.840	2 7/16	4 1/4
2/0	1/2	6227	.420	.840	2 7/16	4 1/4
3/0	1/2	6228	.471	.840	2 7/16	4 1/4
4/0	1/2	6229	.533	.840	2 7/16	4 1/4
250,000	1/2	6230	.576	.840	2 7/16	4 1/4
300,000	1/2	6231	.631	.840	2 7/16	4 1/4
350,000	1/2	6232	.682	.840	2 7/16	4 1/4
1/0	3/4	6233	.374	1.050	2 7/16	4 1/4
2/0	3/4	6234	.420	1.050	2 7/16	4 1/4
3/0	3/4	6235	.471	1.050	2 7/16	4 1/4
4/0	3/4	6236	.533	1.050	2 7/16	4 1/4
250,000	3/4	6237	.576	1.050	2 7/16	4 1/4
300,000	3/4	6238	.631	1.050	2 7/16	4 1/4
350,000	3/4	6239	.682	1.050	2 7/16	4 1/4
500,000	3/4	6240	.815	1.050	2 7/16	4 1/4
1/0	1	6241	.374	1.315	2 7/16	4 1/4
2/0	1	6242	.420	1.315	2 7/16	4 1/4
3/0	1	6243	.471	1.315	2 7/16	4 1/4
4/0	1	6244	.533	1.315	2 7/16	4 1/4
250,000	1	6245	.576	1.315	2 7/16	4 1/4
300,000	1	6246	.631	1.315	2 7/16	4 1/4
350,000	1	6247	.682	1.315	2 7/16	4 1/4
500,000	1	6248	.815	1.315	2 7/16	4 1/4
750,000	1	6249	.999	1.315	2 7/16	4 1/4
1/0	1 1/4	6250	.375	1.660	2 3/4	5 5/8
2/0	1 1/4	6251	.420	1.660	2 3/4	5 5/8
3/0	1 1/4	6252	.471	1.660	2 3/4	5 5/8
4/0	1 1/4	6253	.533	1.660	2 3/4	5 5/8
250,000	1 1/4	6254	.576	1.660	2 3/4	5 5/8
300,000	1 1/4	6255	.631	1.660	2 3/4	5 5/8
350,000	1 1/4	6256	.682	1.660	2 3/4	5 5/8
500,000	1 1/4	6257	.815	1.660	2 3/4	5 5/8
750,000	1 1/4	6258	.999	1.660	2 3/4	5 5/8
1,000,000	1 1/4	6259	1.153	1.660	2 3/4	5 5/8
1,250,000	1 1/4	6260	1.289	1.660	2 3/4	5 5/8
4/0	1 1/2	6261	.533	1.900	2 3/4	5 5/8
250,000	1 1/2	6262	.576	1.990	2 3/4	5 5/8
300,000	1 1/2	6263	.631	1.900	2 3/4	5 5/8
350,000	1 1/2	6264	.682	1.900	2 3/4	5 5/8
500,000	1 1/2	6265	.815	1.900	2 3/4	5 5/8
750,000	1 1/2	6266	.999	1.900	2 3/4	5 5/8
1,000,000	1 1/2	6267	1.153	1.900	2 3/4	5 5/8
1,250,000	1 1/2	6268	1.289	1.900	2 3/4	5 5/8
1,500,000	1 1/2	6269	1.413	1.900	2 3/4	5 5/8

Example for ordering: - #6262 Royal Type RCP Tee Connector 250 MCM Run - 1 1/2" tap.

Silicon Bronze bolts, nuts and lockwashers are standard.

Bolt heads are nested between ears on the casting which prevents the bolt head from turning, and permits one wrench installation.

Certified dimension prints will be furnished on request.

Special or unlisted sizes readily furnished.

NOTE: 1/2" bolts are furnished as STANDARD for 1/2" IPS tubing and larger, and 500 MCM cable and larger.

NOTE: This connector will meet or exceed NEMA requirements for Class CF-1; Pub. SG-1.

### ROYAL SWITCHGEAR MANUFACTURING CO.

3995 Pine Lane SE • Bessemer, AL 35023 • (205) 426-4090 • FAX (205) 426-4095

# Ab-10 POWER CONNECTORS

## TEE CONNECTOR TYPE RCP

Cable Run	IPS Tap	Cat. No.	Max. Dimensions in Inches			
			A	B	C	D
4/0	2	6270	.533	2.375	3	6 3/4
250,000	2	6271	.576	2.375	3	6 3/4
300,000	2	6272	.631	2.375	3	6 3/4
350,000	2	6273	.682	2.375	3	6 3/4
500,000	2	6274	.815	2.375	3	6 3/4
750,000	2	6275	.999	2.375	3	6 3/4
1,000,000	2	6276	1.153	2.375	3	6 3/4
1,250,000	2	6277	1.289	2.375	3	6 3/4
1,500,000	2	6278	1.414	2.375	3	6 3/4
1,750,000	2	6279	1.527	2.375	3	6 3/4
2,000,000	2	6280	1.632	2.375	3	6 3/4
4/0	2 1/2	6281	.533	2.875	3 1/2	7
250,000	2 1/2	6282	.576	2.875	3 1/2	7
300,000	2 1/2	6283	.631	2.875	3 1/2	7
350,000	2 1/2	6284	.682	2.875	3 1/2	7
500,000	2 1/2	6285	.815	2.875	3 1/2	7
750,000	2 1/2	6286	.999	2.875	3 1/2	7
1,000,000	2 1/2	6287	1.153	2.875	3 1/2	7
1,250,000	2 1/2	6288	1.289	2.875	3 1/2	7
1,500,000	2 1/2	6289	1.413	2.875	3 1/2	7
1,750,000	2 1/2	6290	1.527	2.875	3 1/2	7
2,000,000	2 1/2	6291	1.632	2.875	3 1/2	7
4/0	3	1065	.533	3.500	4	8
250,000	3	1066	.576	3.500	4	8
300,000	3	1067	.631	3.500	4	8
350,000	3	1068	.682	3.500	4	8
500,000	3	1069	.815	3.500	4	8
750,000	3	1323	.999	3.500	4	8
1,000,000	3	1324	1.153	3.500	4	8
1,250,000	3	1325	1.289	3.500	4	8
1,500,000	3	1326	1.413	3.500	4	8
1,750,000	3	1327	1.527	3.500	4	8
2,000,000	3	1328	1.632	3.500	4	8
4/0	3 1/2	1329	.533	4.000	4	9
250,000	3 1/2	1330	.576	4.000	4	9
300,000	3 1/2	1259	.631	4.000	4	9
350,000	3 1/2	1260	.682	4.000	4	9
500,000	3 1/2	1261	.815	4.000	4	9
750,000	3 1/2	1262	.999	4.000	4	9
1,000,000	3 1/2	1263	1.153	4.000	4	9
1,250,000	3 1/2	1264	1.289	4.000	4	9
1,500,000	3 1/2	1265	1.413	4.000	4	9
1,750,000	3 1/2	1266	1.527	4.000	4	9
2,000,000	3 1/2	1267	1.632	4.000	4	9
4/0	4	1268	.533	4.500	5 3/8	9
250,000	4	1269	.576	4.500	5 3/8	9
300,000	4	1270	.631	4.500	5 3/8	9
350,000	4	1271	.682	4.500	5 3/8	9
500,000	4	1272	.815	4.500	5 3/8	9
750,000	4	1273	.999	4.500	5 3/8	9
1,000,000	4	1274	1.153	4.500	5 3/8	9
1,250,000	4	1275	1.289	4.500	5 3/8	9
1,500,000	4	1276	1.413	4.500	5 3/8	9
1,750,000	4	1277	1.527	4.500	5 3/8	9
2,000,000	4	1361	1.632	4.500	5 3/8	9

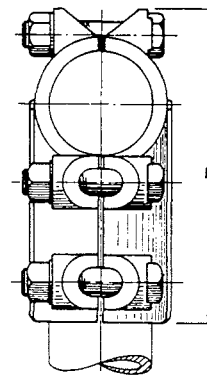
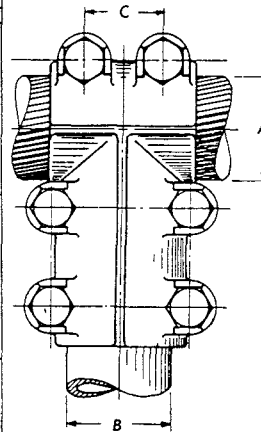

Example for ordering: - #1260 Royal Type RCP Tee Connectors 350 MCM Run - 3 1/2" IPS Tap.

Silicon Bronze bolts, nuts and lockwashers are standard. Bolt heads are nested between ears on the casting which prevents the bolt head from turning, and permits one wrench installation.

Certified dimension prints will be furnished on request. Special or unlisted sizes readily furnished.

NOTE: 1/2" bolts are furnished as STANDARD for 1/2" IPS tubing and larger, and 500 MCM cable and larger.

NOTE: This connector will meet or exceed NEMA requirements for Class CF-1; Pub. SG-1.

### ROYAL SWITCHGEAR MANUFACTURING CO.

3995 Pine Lane SE • Bessemer, AL 35023 • (205) 426-4090 • FAX (205) 426-4095

# POWER CONNECTORS Ab-11

## TEE CONNECTOR TYPE RTC

Ab-11 Tee Conn

Reversible Tube To Cable

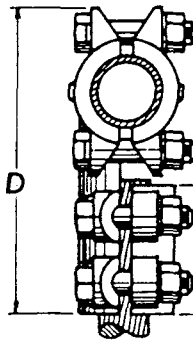
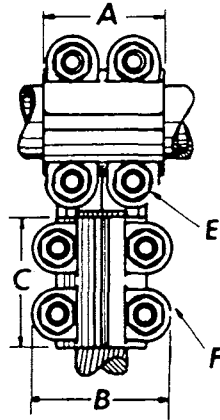

Cat. No.	IPS Cable Range		Max. Dimensions in Inches					
	Run	Tap	A	B	C	D	E	F
17712	1/2	#6-250	2 3/8	2 1/4	2 3/4	4 3/4	1/2	3/8
17713	1/2	1/0-500	2 3/8	2 1/2	3 1/2	4 3/4	1/2	1/2
17714	3/4	#6-250	2 5/8	2 1/4	2 3/4	5 3/8	1/2	3/8
17715	3/4	1/0-500	2 5/8	2 1/2	3 1/2	5 5/8	1/2	1/2
17716	1	#6-250	2 7/8	2 1/4	2 3/4	5 5/8	1/2	3/8
17717	1	1/0-500	2 7/8	2 1/2	3 1/2	5 7/8	1/2	1/2
17718	1	4/0-1000	2 7/8	3 1/4	4 1/4	6 5/8	1/2	1/2
17719	1 1/4	#6-250	3 1/8	2 1/4	2 3/4	6	1/2	3/8
17720	1 1/4	1/0-500	3 1/8	2 1/2	3 1/2	6 1/4	1/2	1/2
17721	1 1/4	4/0-1000	3 1/8	3 1/4	4 1/4	7	1/2	1/2
17722	1 1/4	500-2000	3 1/8	3 3/4	5	7 3/8	1/2	1/2
17723	1 1/2	#6-250	3 1/4	2 1/4	2 3/4	6 1/4	1/2	3/8
17724	1 1/2	1/0-500	3 1/4	2 1/2	3 1/2	6 1/2	1/2	1/2
17725	1 1/2	4/0-1000	3 1/4	3 1/4	4 1/4	7 1/8	1/2	1/2
17726	1 1/2	500-2000	3 1/4	3 3/4	5	7 1/2	1/2	1/2
17727	2	#6-250	3 3/8	2 1/4	2 3/4	6 1/2	1/2	3/8
17728	2	1/0-500	3 3/8	2 1/2	3 1/2	6 3/4	1/2	1/2
17729	2	4/0-1000	3 3/8	3 1/4	4 1/4	7 5/8	1/2	1/2
17730	2	500-2000	3 3/8	3 3/4	5	7 3/4	1/2	1/2
17731	2 1/2	#6-250	3 1/2	2 1/4	2 3/4	6 3/8	1/2	3/8
17732	2 1/2	1/0-500	3 1/2	2 1/2	3 1/2	6 7/8	1/2	1/2
17733	2 1/2	4/0-1000	3 1/2	3 1/4	4 1/4	7 3/4	1/2	1/2
17734	2 1/2	500-2000	3 1/2	3 3/4	5	7 7/8	1/2	1/2
17735	3	1/0-500	3 3/4	2 1/2	3 1/2	7 1/8	5/8	1/2
17736	3	4/0-1000	3 3/4	3 1/4	4 1/4	7 7/8	5/8	1/2
17737	3	500-2000	3 3/4	3 3/4	5	8 1/8	5/8	1/2
17738	3	1250-2500	3 3/4	4 1/2	5 1/2	8 1/2	5/8	5/8
17739	3 1/2	1/0-500	4	2 1/2	3 1/2	7 3/8	5/8	1/2
17740	3 1/2	4/0-1000	4	3 1/4	4 1/4	8	5/8	1/2
17741	3 1/2	500-2000	4	3 3/4	5	8 3/8	5/8	1/2
17742	3 1/2	1250-2500	4	4 1/2	5 1/2	8 3/4	5/8	5/8
17743	4	1/0-500	4 1/2	2 1/2	3 1/2	7 5/8	5/8	1/2
17744	4	4/0-1000	4 1/2	3 1/4	4 1/4	8 1/4	5/8	1/2
17745	4	500-2000	4 1/2	3 3/4	5	8 5/8	5/8	1/2
17746	4	1250-2500	4 1/2	4 1/2	5 1/2	9	5/8	5/8

Example for Ordering: - #17734 Royal Type RTC Tee Connector 2-1/2" IPS Run to 500-2,000 MCM Tap.

Silicon Bronze bolts, nuts and lockwashers are standard.

Bolt heads are nested between ears on the casting which prevents the bolt head from turning, and permits one wrench installation.

Certified dimension prints will be furnished on request.

Special or unlisted sizes readily furnished.

NOTE: 1/2" bolts are furnished as STANDARD for 1/2" IPS tubing and larger, and 500 MCM cable and larger.

NOTE: This connector will meet or exceed NEMA requirements for Class CF-1; Pub. SG-1.

**ROYAL SWITCHGEAR MANUFACTURING CO.**

3995 Pine Lane SE • Bessemer, AL 35023 • (205) 426-4090 • FAX (205) 426-4095

# Ab-12 POWER CONNECTORS

## TEE CONNECTOR TYPE RCC

Reversible Cable To Cable

Cat. No.	Cable Range		Max. Dimensions in Inches					
	Run	Tap	A	B	C	D	E	F
17747	#6-250	#6-250	2 3/4	2 1/4	2 1/2	4 7/8	3/8	3/8
17748	#6-250	1/0-500	2 3/4	2 1/2	2 3/4	5	3/8	1/2
17749	1/0-500	#6-250	3	2 1/4	2 1/2	5 1/8	1/2	3/8
17750	1/0-500	1/0-500	3	2 1/2	2 3/4	5 3/8	1/2	1/2
17751	1/0-500	4/0-1000	3	3 1/4	3 1/2	5 3/4	1/2	1/2
17752	4/0-1000	#6-250	3 1/2	2 1/4	2 1/2	5 1/2	1/2	1/2
17753	4/0-1000	1/0-500	3 1/2	2 1/2	2 3/4	5 3/4	1/2	1/2
17754	4/0-1000	4/0-1000	3 1/2	3 1/4	3 1/2	6 7/8	1/2	1/2
17755	4/0-1000	500-2000	3 1/2	3 3/4	3 3/4	7	1/2	1/2
17756	500-2000	1/0-500	4 1/2	2 1/2	2 3/4	6 1/2	1/2	1/2
17757	500-2000	4/0-1000	4 1/2	3 1/4	3 1/2	6 7/8	1/2	1/2
17758	500-2000	500-2000	4 1/2	3 3/4	3 3/4	7 1/2	1/2	1/2
17759	500-2000	1250-2500	4 1/2	4 1/2	4 1/2	7 3/4	1/2	5/8
17760	1250-2500	1/0-500	5	2 1/2	2 3/4	7	5/8	1/2
17761	1250-2500	4/0-1000	5	3 1/4	3 1/2	7 1/4	5/8	1/2
17762	1250-2500	500-2000	5	3 3/4	3 3/4	7 1/2	5/8	1/2
17763	1250-2500	1250-2500	5	4 1/2	4 1/2	8	5/8	5/8
17764	1250-2500	2500-3000	5	5	5	8 1/2	5/8	5/8

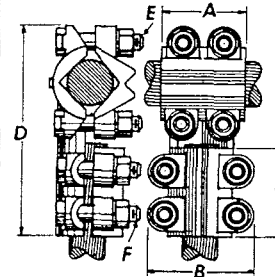

Example for Ordering: - #17750 Royal Type RCC Tee Connector 1/0-500 MCM Cable Run and Tap.

Silicon Bronze bolts, nuts and lockwashers are standard.

Bolt heads are nested between ears on the casting which prevents the bolt head from turning, and permits one wrench installation.

Certified dimension prints will be furnished on request.

Special or unlisted sizes readily furnished.

NOTE: 1/2" bolts are furnished as STANDARD for 1/2" IPS tubing and larger, and 500 MCM cable and larger.

NOTE: This connector will meet or exceed NEMA requirements for Class CF-1; Pub. SG-1.

## TYPE RP-L

Cat. No.	IPS Size		Dimensions in Inches				
	Run	Tap	A	B	C	D	S
17832	3/8	3/8	.675	.675	1 1/4	2 3/4	3/8
17833	1/2	1/2	.840	.840	1 1/2	3 1/4	1/2
17834	3/4	1/2	1.050	.840	1 1/2	3 1/2	1/2
17835	3/4	3/4	1.050	1.050	1 3/4	4	1/2
17836	1	1/2	1.315	.840	1 1/2	3 3/4	1/2
17837	1	3/4	1.315	1.050	1 3/4	4 1/4	1/2
17838	1 1/4	1/2	1.660	.840	1 1/2	4 1/4	1/2
17839	1 1/4	3/4	1.660	1.050	1 3/4	4 1/2	1/2
17840	1 1/2	1/2	1.900	.840	1 1/2	4 1/2	1/2
17841	1 1/2	3/4	1.900	1.050	1 3/4	4 3/4	1/2
17842	2	1/2	2.375	.840	1 1/2	4 3/4	1/2
17843	2	3/4	2.375	1.050	1 3/4	5 1/4	1/2
17844	2 1/2	1/2	2.875	.840	1 1/2	6	1/2
17845	2 1/2	3/4	2.875	1.050	1 3/4	6	1/2

Example for Ordering: - #17837 Royal Type RP-L Tee Connector 1" IPS Run - 3/4" IPS Tap.

Light Duty Tee Connectors for rural distribution and industrial substations. These connectors will meet full current rating of the conductors for which they are listed.

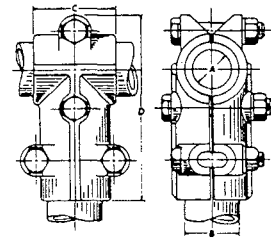

**ROYAL SWITCHGEAR MANUFACTURING CO.**

3995 Pine Lane SE • Bessemer, AL 35023 • (205) 426-4090 • FAX (205) 426-4095

# POWER CONNECTORS Ab-13

## TEE CONNECTOR TYPE PCU

Ab-Tee Conn

NEMA Class CR-2

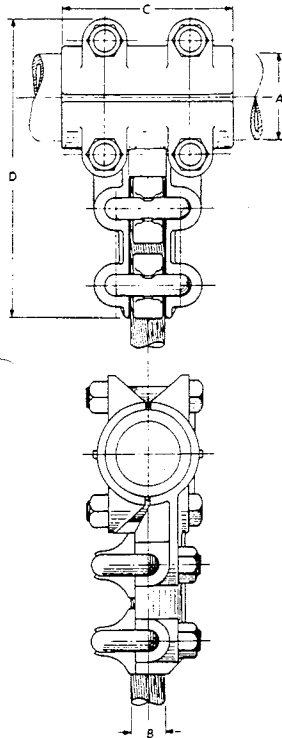

IPS Run	Cable Tap		Cat. No.	Max. Dimensions in inches			
	Min.	Max.		A	B	C	D
1/2	#6	2/0	6158	.840	.420	2 1/2	4 7/8
1/2	#1	4/0	6159	.840	.533	2 1/2	4 7/8
1/2	1/0	300,000	6160	.840	.631	2 1/2	4 7/8
3/4	#6	2/0	6161	1.050	.420	2 1/2	5 1/2
3/4	#1	4/0	6162	1.050	.533	2 1/2	5 1/2
3/4	1/0	300,000	6163	1.050	.631	2 1/2	5 1/2
3/4	300,000	500,000	6164	1.050	.815	2 1/2	6 3/8
1	#6	2/0	6165	1.315	.420	2 3/4	5 3/4
1	#1	4/0	6166	1.315	.533	2 3/4	5 3/4
1	1/0	300,000	6167	1.315	.631	2 3/4	5 3/4
1	300,000	500,000	6168	1.315	.815	2 3/4	6 1/4
1	500,000	800,000	6169	1.315	1.031	2 3/4	6 3/4
1 1/4	#1	4/0	6170	1.660	.533	3	6 1/4
1 1/4	1/0	300,000	6171	1.660	.631	3	6 1/4
1 1/4	300,000	500,000	6172	1.660	.815	3	6 1/4
1 1/4	500,000	800,000	6173	1.660	1.031	3	6 3/4
1 1/4	750,000	1,000,000	6174	1.660	1.153	3	7
1 1/2	#1	4/0	6175	1.900	.533	3 1/2	6 3/4
1 1/2	1/0	300,000	6176	1.900	.631	3 1/2	6 3/4
1 1/2	300,000	500,000	6177	1.900	.815	3 1/2	6 3/4
1 1/2	500,000	800,000	6178	1.900	1.031	3 1/2	7
1 1/2	750,000	1,000,000	6179	1.900	1.153	3 1/2	7
2	#1	4/0	6180	2.375	.533	3 1/2	7
2	1/0	300,000	6181	2.375	.631	3 1/2	7
2	300,000	500,000	6182	2.375	.815	3 1/2	7 1/2
2	500,000	800,000	6183	2.375	1.031	3 1/2	7 3/4
2	750,000	1,000,000	6184	2.375	1.153	3 1/2	7 3/4
2	1,000,000	1,500,000	6185	2.375	1.413	3 1/2	8 1/4
2 1/2	#1	4/0	6186	2.875	.533	3 1/2	7 7/8
2 1/2	1/0	300,000	6187	2.875	.631	3 1/2	7 7/8
2 1/2	300,000	500,000	6188	2.875	.815	3 1/2	8
2 1/2	500,000	800,000	6189	2.875	1.031	3 1/2	8
2 1/2	750,000	1,000,000	6190	2.875	1.153	3 1/2	8
2 1/2	1,000,000	1,500,000	6191	2.875	1.413	3 1/2	8 3/4
3	#1	4/0	6192	3.500	.533	3 1/2	8 1/4
3	1/0	300,000	6193	3.500	.631	3 1/2	8 1/4
3	300,000	500,000	6194	3.500	.815	3 1/2	8 3/4
3	500,000	800,000	6195	3.500	1.031	3 1/2	9 1/4
3	750,000	1,000,000	6196	3.500	1.153	3 1/2	9 3/4
3	1,000,000	1,500,000	6197	3.500	1.413	3 1/2	9 3/4
3 1/2	#1	4/0	1405	4.000	.533	4	8 1/4
3 1/2	1/0	300,000	1406	4.000	.631	4	8 1/2
3 1/2	300,000	500,000	1407	4.000	.815	4	8 3/4
3 1/2	500,000	800,000	1408	4.000	1.031	4	9 1/2
3 1/2	750,000	1,000,000	1409	4.000	1.153	4	10 1/2
3 1/2	1,000,000	1,500,000	1410	4.000	1.413	4	11 1/4
4	#1	4/0	1411	4.500	.533	4	8 3/4
4	1/0	300,000	1412	4.500	.631	4	9 1/4
4	300,000	500,000	1413	4.500	.815	4	9 1/4
4	500,000	800,000	1414	4.500	1.031	4	10 1/4
4	750,000	1,000,000	1415	4.500	1.153	4	10 1/2
4	1,000,000	1,500,000	1416	4.500	1.413	4	10 3/4
4	1,500,000	2,000,000	1417	4.500	1.632	4	11

Example for ordering: - #1415 Royal Type PCU Tee Connectors 4" IPS run - 750 to 1,000 MCM Tap.

Silicon Bronze bolts, nuts and lockwashers are standard.

Bolt heads are nested between ears on the casting which prevents the bolt head from turning, and permits one wrench installation.

Certified dimension prints will be furnished on request.

Special or unlisted sizes readily furnished.

NOTE: 1/2" bolts are furnished as STANDARD for 1/2" IPS tubing and larger, and 500 MCM cable and larger.

Independent keepers assembled captive on "U" bolts provide highest contact pressure.

### ROYAL SWITCHGEAR MANUFACTURING CO.

3995 Pine Lane SE • Bessemer, AL 35023 • (205) 426-4090 • FAX (205) 426-4095

# Ab-14 POWER CONNECTORS

## TEE CONNECTOR TYPE PCU-2

Two Conductor - Tap							
IPS Run	Cable Tap		Cat. No.	Max. Dimensions in Inches			
	Min.	Max.		A	B	C	D
1	#6	2/0	17765	1.315	.420	2 3/4	5 3/4
1	#1	4/0	17766	1.315	.533	2 3/4	5 3/4
1	1/0	300,000	17767	1.315	.631	2 3/4	5 3/4
1	300,000	500,000	17768	1.315	.815	2 3/4	6 1/4
1	500,000	800,000	17769	1.315	1.031	2 3/4	6 3/4
1 1/4	#1	4/0	17770	1.660	.533	3	6 1/4
1 1/4	1/0	300,000	17771	1.660	.631	3	6 1/4
1 1/4	300,000	500,000	17772	1.660	.815	3	6 1/4
1 1/4	500,000	800,000	17773	1.660	1.031	3	6 3/4
1 1/4	750,000	1,000,000	17774	1.660	1.153	3	7
1 1/2	#1	4/0	17775	1.900	.533	3 1/2	6 3/4
1 1/2	1/0	300,000	17776	1.900	.631	3 1/2	6 3/4
1 1/2	300,000	500,000	17777	1.900	.815	3 1/2	6 3/4
1 1/2	500,000	800,000	17778	1.900	1.031	3 1/2	7
1 1/2	750,000	1,000,000	17779	1.900	1.153	3 1/2	7
2	#1	4/0	17780	2.375	.533	3 1/2	7
2	1/0	300,000	17781	2.375	.631	3 1/2	7
2	300,000	500,000	17782	2.375	.815	3 1/2	7 1/2
2	500,000	800,000	17783	2.375	1.031	3 1/2	7 3/4
2	750,000	1,000,000	17784	2.375	1.153	3 1/2	7 3/4
2	1,000,000	1,500,000	17785	2.375	1.413	3 1/2	8 1/4
2 1/2	#1	4/0	17786	2.875	.533	3 1/2	7 7/8
2 1/2	1/0	300,000	17787	2.875	.631	3 1/2	7 7/8
2 1/2	300,000	500,000	17788	2.875	.815	3 1/2	8
2 1/2	500,000	800,000	17789	2.875	1.031	3 1/2	8
2 1/2	750,000	1,000,000	17790	2.875	1.153	3 1/2	8
2 1/2	1,000,000	1,500,000	17791	2.875	1.413	3 1/2	8 3/4
3	#1	4/0	17792	3.500	.533	3 1/2	8 1/2
3	1/0	300,000	17793	3.500	.631	3 1/2	8 1/2
3	300,000	500,000	17794	3.500	.815	3 1/2	8 3/4
3	500,000	800,000	17795	3.500	1.031	3 1/2	9 1/4
3	750,000	1,000,000	17796	3.500	1.153	3 1/2	9 3/4
3	1,000,000	1,500,000	17797	3.500	1.413	3 1/2	9 3/4
3 1/2	#1	4/0	17798	4.000	.533	4	8 1/4
3 1/2	1/0	300,000	17799	4.000	.631	4	8 1/2
3 1/2	300,000	500,000	17800	4.000	.815	4	8 3/4
3 1/2	500,000	800,000	17801	4.000	1.031	4	9 1/2
3 1/2	750,000	1,000,000	17802	4.000	1.153	4	10 1/2
3 1/2	1,000,000	1,500,000	17803	4.000	1.413	4	11 1/4

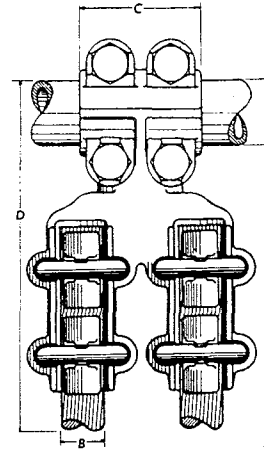

Example for Ordering: - #17784 Royal Type PCU-2 Tee Connectors 2" IPS Run - to Two 750-1,000 MCM Cables Tap.

Silicon Bronze bolts, nuts and lockwashers are standard.

Bolt heads are nested between ears on the casting which prevents the bolt head from turning, and permits one wrench installation.

Certified dimension prints will be furnished on request.

Special or unlisted sizes readily furnished.

NOTE: 1/2" bolts are furnished as STANDARD for 1/2" IPS tubing and larger, and 500 MCM cable and larger.

Independent keepers assembled captive on "U" bolts provide highest contact pressure.

## ROYAL SWITCHGEAR MANUFACTURING CO.

3995 Pine Lane SE • Bessemer, AL 35023 • (205) 426-4090 • FAX (205) 426-4095

# POWER CONNECTORS Ab-15

## TEE CONNECTORS TYPE PCU-L

Ab-15 Tee Conn

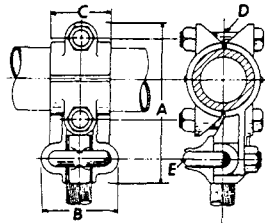

LIGHT DUTY

IPS Run	Cable Tap		Cat. No.	Max. Dimensions in Inches				
	Min.	Max.		A	B	C	D	E
1/2	#6 SOL	2/0	17804	4 1/4	1 1/2	1 1/2	1/2	3/8
1/2	1/0	4/0	17805	4 1/4	1 1/2	1 1/2	1/2	3/8
3/4	#6 SOL	2/0	17806	4 1/2	1 1/2	1 1/2	1/2	3/8
3/4	1/0	4/0	17807	4 1/2	1 1/2	1 1/2	1/2	3/8
1	#6 SOL	2/0	17808	4 1/2	1 1/2	1 1/2	1/2	3/8
1	1/0	4/0	17809	4 1/2	1 1/2	1 1/2	1/2	3/8
1 1/4	#6 SOL	2/0	17810	5 1/4	1 1/2	1 1/2	1/2	3/8
1 1/4	1/0	4/0	17811	5 1/4	1 1/2	1 1/2	1/2	3/8
1 1/2	#6 SOL	2/0	17812	5 1/4	1 1/2	1 3/4	1/2	3/8
1 1/2	1/0	4/0	17813	5 1/4	1 1/2	1 3/4	1/2	3/8
2	#6 SOL	2/0	17814	5 5/8	1 1/2	1 3/4	1/2	3/8
2	1/0	4/0	17815	5 5/8	1 1/2	1 3/4	1/2	3/8
2 1/2	#6 SOL	2/0	17816	5 5/8	1 1/2	1 3/4	1/2	3/8
2 1/2	1/0	4/0	17817	5 5/8	1 1/2	1 3/4	1/2	3/8

Example for Ordering: - #17810 Royal Type PCU-L Tee Connector 1-1/4 IPS Run - 2/0 Tap.

Light Duty Tee Connectors for Rural Distribution and Industrial Substations.

## TYPE UCU-L

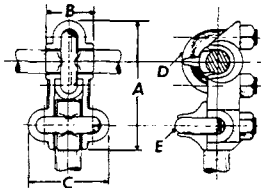

LIGHT DUTY

Cable Run		Cable Tap		Cat. No.	Max. Dimensions in Inches				
Min.	Max.	Min.	Max.		A	B	C	D	E
#6 SOL	2/0	#6 SOL	2/0	17818	4 1/4	1 1/2	1 1/2	3/8	3/8
#6 SOL	2/0	#1 SOL	4/0	17819	4 1/4	1 1/2	1 1/2	3/8	3/8
#1 SOL	4/0	#6 SOL	2/0	17820	4 1/4	1 1/2	1 1/2	3/8	3/8
#1 SOL	4/0	#1 SOL	4/0	17821	4 1/4	1 1/2	1 1/2	3/8	3/8
1/0	300	#6 SOL	2/0	17822	4 1/4	1 1/2	1 1/2	3/8	3/8
1/0	300	#1 SOL	4/0	17823	4 1/4	1 1/2	1 1/2	3/8	3/8
300	500	#6 SOL	2/0	17824	4 1/4	1 3/4	1 1/2	1/2	3/8
300	500	#1 SOL	4/0	17825	4 1/4	1 3/4	1 1/2	1/2	3/8
500	800	#6 SOL	2/0	17826	4 1/4	1 3/4	1 1/2	1/2	3/8
500	800	#1 SOL	4/0	17827	4 3/4	1 3/4	1 1/2	1/2	3/8
750	1000	#6 SOL	2/0	17828	4 3/4	1 3/4	1 1/2	1/2	3/8
750	1000	#1 SOL	4/0	17829	4 3/4	1 3/4	1 1/2	1/2	3/8
1000	1500	#6 SOL	2/0	17830	4 3/4	1 3/4	1 1/2	1/2	3/8
1000	1500	#1 SOL	4/0	17831	4 3/4	1 3/4	1 1/2	1/2	3/8

Example for Ordering: - #17828 Royal Type UCU-L Tee Connector 1,000 MCM Run - 2/0 Tap.

Silicon Bronze bolts, nuts and lockwashers are standard.

Certified dimension prints will be furnished on request.

Special or unlisted sizes readily furnished.

NOTE: 1/2" bolts are furnished as STANDARD for 1/2" IPS tubing and larger, and 500 MCM cable and larger.

Independent keepers assembled captive on "U" bolts provide highest contact pressure.

Light Duty Tee Connectors for Rural Distribution and Industrial Substations.

### ROYAL SWITCHGEAR MANUFACTURING CO.

3995 Pine Lane SE • Bessemer, AL 35023 • (205) 426-4090 • FAX (205) 426-4095



# Ab-16 POWER CONNECTORS

## TEE CONNECTOR TYPE UCP

NEMA Class CR-2

Cable Min.	Run Max.	IPS Tap	Cat. No.	Max. Dimensions in Inches			
				A	B	C	D
#6	2/0	1/2	1362	.420	.840	2 3/4	4 3/4
#1	4/0	1/2	1363	.533	.840	2 3/4	5
1/0	300,000	1/2	1364	.631	.840	2 3/4	5 1/4
#6	2/0	3/4	1365	.420	1.050	2 3/4	5 1/2
#1	4/0	3/4	1366	.533	1.050	2 3/4	5 1/2
1/0	300,000	3/4	1367	.631	1.050	2 3/4	5 1/2
300,000	500,000	3/4	1368	.815	1.050	3	6
#6	2/0	1	1369	.420	1.315	2 3/4	5 3/4
#1	4/0	1	1457	.533	1.315	2 3/4	5 3/4
1/0	300,000	1	1458	.631	1.315	2 3/4	5 3/4
300,000	500,000	1	1459	.815	1.315	3	6 1/4
500,000	800,000	1	1460	1.031	1.315	3 1/2	6 3/4
#1	4/0	1 1/4	1461	.533	1.660	2 3/4	6 1/4
1/0	300,000	1 1/4	1462	.631	1.660	2 3/4	6 1/4
300,000	500,000	1 1/4	1463	.815	1.660	3	6 1/4
500,000	800,000	1 1/4	1464	1.031	1.660	3 1/2	6 3/4
750,000	1,000,000	1 1/4	1465	1.153	1.660	3 1/2	7
#1	4/0	1 1/2	1466	.533	1.900	2 3/4	6 3/4
1/0	300,000	1 1/2	1467	.631	1.900	2 3/4	6 3/4
300,000	500,000	1 1/2	1468	.815	1.900	3	6 3/4
500,000	800,000	1 1/2	1469	1.031	1.900	3 1/2	7
750,000	1,000,000	1 1/2	1470	1.153	1.900	3 1/2	7
#1	4/0	2	1471	.533	2.375	2 3/4	7
1/0	300,000	2	1472	.631	2.375	2 3/4	7
300,000	500,000	2	1473	.815	2.375	3	7 1/2
500,000	800,000	2	1474	1.031	2.375	3 1/2	7 3/4
750,000	1,000,000	2	1475	1.153	2.375	3 1/2	7 3/4
1,000,000	1,500,000	2	1476	1.413	2.375	3 3/4	8 1/4
#1	4/0	2 1/2	1477	.533	2.875	3	7 7/8
1/0	300,000	2 1/2	1478	.631	2.875	3	7 7/8
300,000	500,000	2 1/2	1479	.815	2.875	3	8
500,000	800,000	2 1/2	1480	1.031	2.875	3 1/2	8
750,000	1,000,000	2 1/2	1481	1.153	2.875	3 3/4	8
1,000,000	1,500,000	2 1/2	1482	1.413	2.875	3 3/4	8 3/4
#1	4/0	3	1483	.533	3.500	4 1/2	8 1/2
1/0	300,000	3	1484	.631	3.500	4 1/2	8 1/2
300,000	500,000	3	1485	.815	3.500	4 1/2	8 3/4
500,000	800,000	3	1486	1.031	3.500	4 1/2	9 1/4
750,000	1,000,000	3	1487	1.153	3.500	5	9 3/4
1,000,000	1,500,000	3	1488	1.413	3.500	5	9 3/4
#1	4/0	3 1/2	1489	.533	4.000	4 1/2	8 3/4
1/0	300,000	3 1/2	1490	.631	4.000	4 1/2	8 3/4
300,000	500,000	3 1/2	1491	.815	4.000	5	9 1/4
500,000	800,000	3 1/2	1492	1.031	4.000	5	9 3/4
750,000	1,000,000	3 1/2	1493	1.153	4.000	5 1/2	9 3/4
1,000,000	1,500,000	3 1/2	1494	1.413	4.000	5 3/4	10
#1	4/0	4	1495	.533	4.500	4 1/2	9
1/0	300,000	4	1496	.631	4.500	4 1/2	9
300,000	500,000	4	1497	.815	4.500	5	9
500,000	800,000	4	1498	1.031	4.500	5	9 3/4
750,000	1,000,000	4	1499	1.153	4.500	5 1/2	10
1,000,000	1,500,000	4	1500	1.413	4.500	5 3/4	10 3/4
1,500,000	2,000,000	4	1501	1.632	4.500	6	11

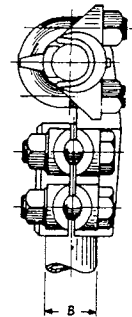
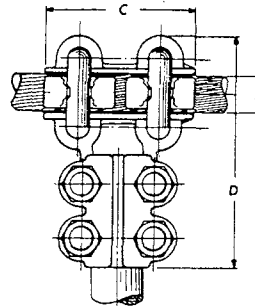

Example for ordering: - #1481 Royal Type UCP Tee Connectors 750 to 1,000 MCM Run - 2 1/2" IPS Tap.

Silicon Bronze bolts, nuts and lockwashers are standard.

Bolt heads are nested between ears on the casting which prevents the bolt head from turning, and permits one wrench installation.

Certified dimension prints will be furnished on request.

Special or unlisted sizes readily furnished.

NOTE: 1/2" bolts are furnished as STANDARD for 1/2" IPS tubing and larger, and 500 MCM cable and larger.

Independent keepers assembled captive on "U" bolts provide highest contact pressure.

### ROYAL SWITCHGEAR MANUFACTURING CO.

3995 Pine Lane SE • Bessemer, AL 35023 • (205) 426-4090 • FAX (205) 426-4095

# POWER CONNECTORS Ab-17

## TEE CONNECTOR TYPE UCU

NEMA Class CR-2

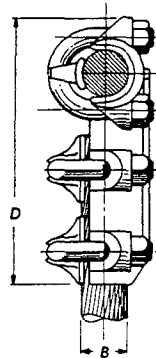
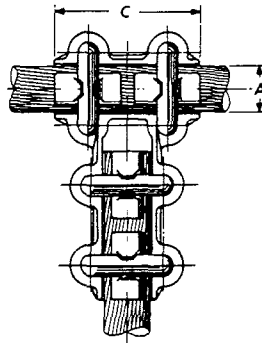

Cable Size				Cat. No.	Max. Dimensions in Inches			
Run		Tap			A	B	C	D
Min.	Max.	Min.	Max.					
#6	2/0	#6	2/0	1418	.420	.420	2 1/2	4 1/2
#6	2/0	#1	4/0	1419	.420	.533	2 1/2	4 1/2
#6	2/0	300	500	1420	.420	.815	2 1/2	4 1/2
1/0	300	#6	2/0	1421	.631	.420	3	5
1/0	300	#1	4/0	1422	.631	.533	3	5
1/0	300	1/0	300	1423	.631	.631	3	5
1/0	300	300	500	1424	.631	.815	3	5
1/0	300	500	800	1425	.631	1.031	3	5
1/0	300	750	1,000	1426	.631	1.153	3	5
300	500	#6	2/0	1427	.815	.420	3 1/2	6 1/8
300	500	#1	4/0	1428	.815	.533	3 1/2	6 1/8
300	500	1/0	300	1429	.815	.631	3 1/2	6 1/8
300	500	300	500	1430	.815	.815	3 1/2	6 1/8
300	500	500	800	1431	.815	1.031	3 1/2	6 1/8
300	500	750	1,000	1432	.815	1.153	3 1/2	6 1/8
500	800	1/0	300	1433	1.031	.631	3 1/2	6
500	800	300	500	1434	1.031	.815	3 1/2	6
500	800	500	800	1435	1.031	1.031	3 1/2	6
500	800	750	1,000	1436	1.031	1.153	3 1/2	6
500	800	1,000	1,500	1437	1.031	1.413	3 1/2	6
500	800	1,500	2,000	1438	1.031	1.632	3 1/2	6
750	1,000	1/0	300	1439	1.153	.631	4	6 1/2
750	1,000	300	500	1440	1.153	.815	4	6 1/2
750	1,000	500	800	1441	1.153	1.031	4	6 1/2
750	1,000	750	1,000	1442	1.153	1.153	4	6 1/2
750	1,000	1,000	1,500	1443	1.153	1.413	4	6 1/2
750	1,000	1,500	2,000	1444	1.153	1.632	4	6 1/2
1,000	1,500	1/0	300	1445	1.413	.631	4	6 3/4
1,000	1,500	300	500	1446	1.413	.815	4	6 3/4
1,000	1,500	500	800	1447	1.413	1.031	4	6 3/4
1,000	1,500	750	1,000	1448	1.413	1.153	4	6 3/4
1,000	1,500	1,000	1,500	1449	1.413	1.413	4	6 3/4
1,000	1,500	1,500	2,000	1450	1.413	1.632	4	6 3/4
1,500	2,000	1/0	300	1451	1.632	.631	4	7 1/2
1,500	2,000	300	500	1452	1.632	.815	4	7 1/2
1,500	2,000	500	800	1453	1.632	1.031	4	7 1/2
1,500	2,000	750	1,000	1454	1.632	1.153	4	7 1/2
1,500	2,000	1,000	1,500	1455	1.632	1.413	4	7 1/2
1,500	2,000	1,500	2,000	1456	1.632	1.632	4	7 1/2

Example for ordering: - #1435 Royal Type UCU Tee Connectors 500 to 800 MCM run and tap.

Silicon Bronze bolts, nuts and lockwashers are standard.  
Certified dimension prints will be furnished on request.  
Special or unlisted sizes readily furnished.

NOTE: 1/2" bolts are furnished as STANDARD for 1/2" IPS tubing and larger, and 500 MCM cable and larger.

Independent keepers assembled captive on "U" bolts provide highest contact pressure.

### ROYAL SWITCHGEAR MANUFACTURING CO.

3995 Pine Lane SE • Bessemer, AL 35023 • (205) 426-4090 • FAX (205) 426-4095

Ab-17a Conn

# Ab-18 POWER CONNECTORS

## TEE CONNECTOR

### TYPE LM

Type LM is a wide application Connector for Tube - Cable - Flat Surface. Can be used as a Tee, Coupler or 90° take off.

Cat. No.	Run		Tap		Max. Dimensions in Inches					
	Cable	IPS	Cable	IPS	A	B	C	D	E	F
15224	#6-850	1/4-3/4	#6-850	1/4-3/4	1/2	6 1/8	3	3	1 3/4	1 3/4
15225	1/0-1500	1/2-1	#6-850	1/4-3/4	1/2	6 3/8	3 1/4	3	2	1 3/4
15226	1/0-1500	1/2-1	4/0-1500	1/2-1	1/2	6 5/8	3 1/4	3 1/4	2	2
15227	850-2000	3/4-1 1/2	#6-850	1/4-3/4	1/2	7 1/8	4	3	2 3/4	1 3/4
15228	850-2000	3/4-1 1/2	4/0-1500	1/2-1	1/2	7 3/8	4	3 1/4	2 3/4	2
15229	850-2000	3/4-1 1/2	850-2000	3/4-1 1/2	1/2	8 1/8	4	4	2 3/4	2 3/4

Example for Ordering: - #15227 Royal Type LM Tee Connector 1-1/4" IPS Run to 750 MCM Tap.

Silicon Bronze bolts, nuts and lockwashers are standard.

Certified dimension prints will be furnished on request.

Special or unlisted sizes readily furnished.

NOTE: 1/2" bolts are furnished as STANDARD for 1/2" IPS tubing and larger, and 500 MCM cable and larger.

NOTE: This connector will meet or exceed NEMA requirements for Class CF-1; Pub. SG-1.

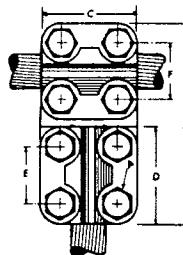

**ROYAL SWITCHGEAR MANUFACTURING CO.**

3995 Pine Lane SE • Bessemer, AL 35023 • (205) 426-4090 • FAX (205) 426-4095

# POWER CONNECTORS Ab-19

Ab-Tee Conn

## PARALLEL CLAMPS

### TYPE DV

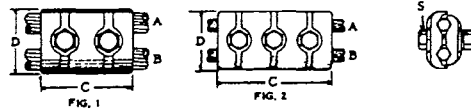

Cat. No.	Cable Range		Dim. in Inches		Bolts S	Fig. No.
	A	B	C	D		
1737	#6 - 2/0	#5 - 2/0	2 1/2	1 3/4	3/8	1
1738	#1 - 4/0	#1 - 4/0	2 1/2	1 3/4	3/8	1
1739	1/0 - 300	1/0 - 300	3 1/2	2 5/8	3/8	1
1740	300 - 500	300 - 500	3 1/2	2 5/8	1/2	1
1741	500 - 750	500 - 750	4 1/2	3 1/2	1/2	2
1742	750 - 1000	750 - 1000	5	3 1/2	1/2	2
2149	1000 - 1500	1000 - 1500	5 1/2	4	1/2	2
2150	1500 - 2000	1500 - 2000	6	4 1/2	1/2	2

Example for Ordering: - #1740 Royal Type DV Parallel Clamp 300-500 MCM Cable.

NOTE: 1/2" bolts are furnished as STANDARD for 1/2" IPS tubing and larger, and 500 MCM cable and larger.

### TYPE DWD

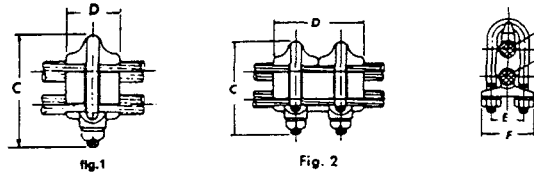

Catalog No.	Silicon Bronze "U" Bolts	Galv. Steel "U" Bolts	Cable Range		Dimensions in Inches				Fig. No.
			A	B	C	D	E	F	
18340	18348	#6, 2/0	#6, 2/0	2 7/16	1 3/8	1 3/16	2	1	
18341	18349	#1, 4/0	#1, 4/0	2 11/16	1 1/2	1 3/8	2 1/4	1	
18342	18350	1/0 - 300 MCM	1/0 - 300 MCM	2 15/16	3	1 5/8	2 3/4	2	
18343	18351	300 - 500 MCM	300 - 500 MCM	3 5/8	3 1/4	1 13/16	2 7/8	2	
18344	18352	500 - 800 MCM	500 - 800 MCM	4 3/16	3 1/2	2 1/8	3	2	
18345	18353	750 - 1000 MCM	750 - 1000 MCM	4 1/2	4	2 3/16	3 1/4	2	
18346	18354	1000 - 1500 MCM	1000 - 1500 MCM	5	4 1/4	2 3/8	3 3/4	2	
18347	18355	1500 - 2000 MCM	1500 - 2000 MCM	5 9/16	4 5/8	2 7/8	4 1/2	2	

Example for Ordering: - #15865 Royal Type DWD parallel Groove Clamp, 750-1000 MCM.

## ROYAL SWITCHGEAR MANUFACTURING CO.

3995 Pine Lane SE • Bessemer, AL 35023 • (205) 426-4090 • FAX (205) 426-4095

# Ab-20 POWER CONNECTORS

## ANGLE TEE CONNECTOR

### TYPE RMC

Tube Size		Cat. No. 30°	Cat. No. 15°
Run	Tap		
3/4	3/4	9439	9458
1	3/4	9440	9459
1	1	9441	9460
1 1/4	3/4	9442	9461
1 1/4	1	9443	9462
1 1/2	1	9444	9463
1 1/2	1 1/4	9445	9464
2	1	9446	9465
2	1 1/4	9447	9466
2 1/2	1 1/4	9448	9467
2 1/2	1 1/2	9449	9468
2 1/2	2	9450	9469
3	3/4	9451	9470
3	1 1/2	9452	9471
3	2	9453	9472
3 1/2	1	9454	9473
3 1/2	1 1/4	9455	9474
3 1/2	1 1/2	9456	9475
3 1/2	2	9457	9476

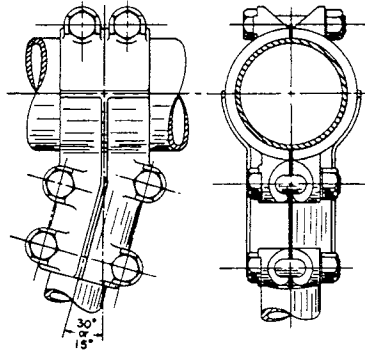

Example for ordering: - #9446 Royal Type RMC Angle Tee Connectors 30°, 2" IPS run 1" IPS tap.

TYPE RMC is used where it is desirable to have an angle between bus on run and tap. It is also used to obtain a truss effect for rigidity.

Certified dimension drawings furnished on request.

TYPE RMC angle tee connectors can be supplied for angles other than 30° or 15° as listed.

Larger sizes available.

## "V" TAP CONNECTOR

### TYPE RMV

Tube Size		Cat. No. 30°	Cat. No. 15°
Run	Taps		
3/4	3/4	9401	9420
1	3/4	9402	9421
1	1	9403	9422
1 1/4	3/4	9404	9423
1 1/4	1	9405	9424
1 1/2	1	9406	9425
1 1/2	1 1/4	9407	9426
2	1	9408	9427
2	1 1/4	9409	9428
2 1/2	1 1/4	9410	9429
2 1/2	1 1/2	9411	9430
2 1/2	2	9412	9431
3	3/4	9413	9432
3	1 1/2	9414	9433
3	2	9415	9434
3 1/2	1	9416	9435
3 1/2	1 1/4	9417	9436
3 1/2	1 1/2	9418	9437
3 1/2	2	9419	9438

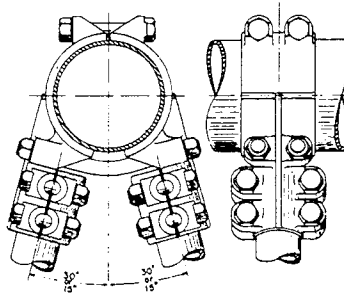

Example for ordering: - #9412 Royal Type RMV V tap connector 30°, 2 1/2" IPS run, 2" IPS tap.

\*V\* TAP connectors for angles other than 30° or 15° can be supplied to specification.

Certified dimension prints furnished on request.

\*V\* TAP connector can be furnished in bronze or aluminum.

Larger sizes available.

Silicon Bronze bolts, nuts and lock washers are standard. Hot galvanized steel bolts and nuts with steel lock washers furnished on request.

All fittings are for standard or extra heavy IPS tubing.

NOTE: 1/2" bolts are furnished as STANDARD for 1/2" IPS tubing and larger and 500 MCM cable and larger.

## ROYAL SWITCHGEAR MANUFACTURING CO.

3995 Pine Lane SE • Bessemer, AL 35023 • (205) 426-4090 • FAX (205) 426-4095