

POWER CONNECTORS

GROUND CLAMPS PICTORIAL INDEX

SECTION Gb

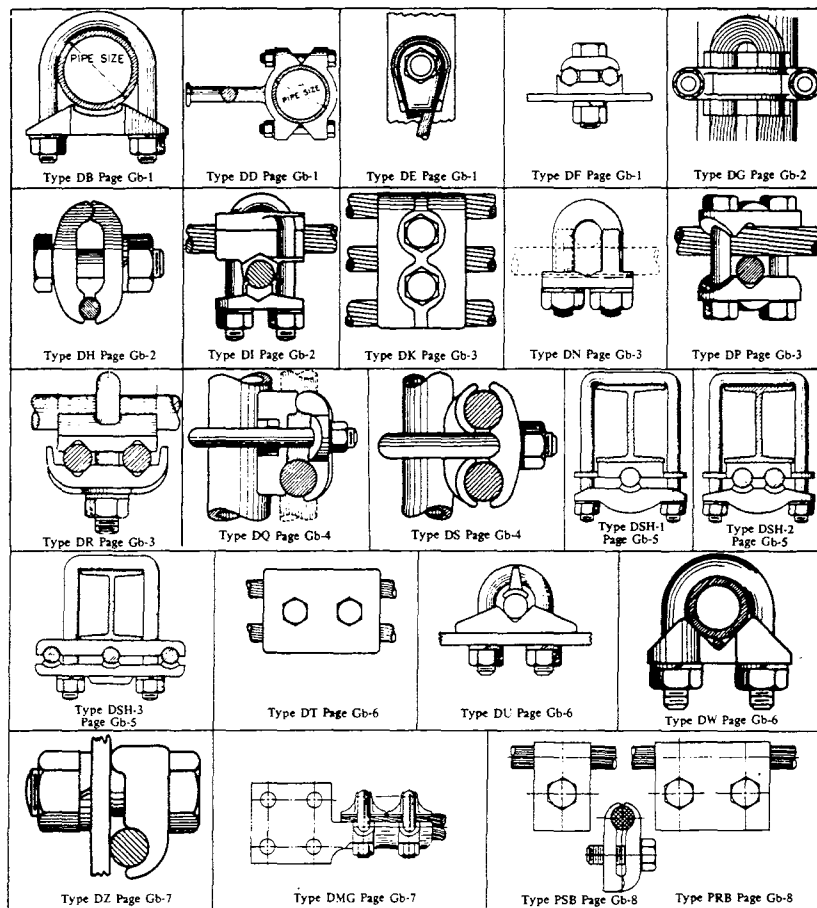

ROYAL SWITCHGEAR MANUFACTURING CO.

3995 Pine Lane SE • Bessemer, AL 35023 • (205) 426-4090 • FAX (205) 426-4095

POWER CONNECTORS Gb-1

GROUND CLAMPS

TYPE DB

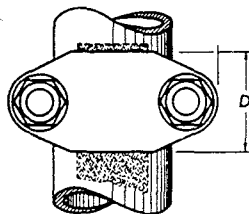

Pipe Size	Cat. No.	Dim. in Inches		
		C	D	S
1	1780	2 1/2	1 3/8	3/8
1 1/4	1781	2 7/8	1 3/8	3/8
1 1/2	1782	3 1/8	1 1/2	3/8
2	1783	4	1 3/4	1/2
2 1/2	1784	4 1/2	2	1/2
3	1785	5 1/8	2 1/4	1/2
3 1/2	1786	5 5/8	2 1/2	1/2
4	1787	6 1/8	2 1/2	1/2

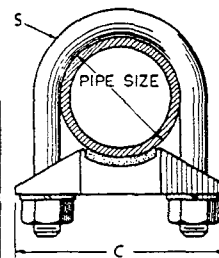

Example for ordering: - #1783 Royal Type DB Ground Clamp
2" Pipe.

Type DB is very effective for making flat flexible braid connections to switch operating mechanisms and handles, gate posts or wherever movement is encountered. Order flexible braid separately.

TYPE DD

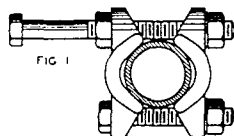

Clamping Bolt
is Extension Arm

Tubing Size	Catalog No.	
	Fig. 1	Fig. 2
3/8 - 1/2	9627	10958
3/4 - 1	9628	10959
1 1/4 - 1 1/2	9629	10960
2	9630	10961
2 1/2	10955	10962
3	10956	10963
4	10957	10964

Example for ordering: - #9629 Royal Type DD Tap Clamp for
1 1/4" - 1 1/2" IPS.

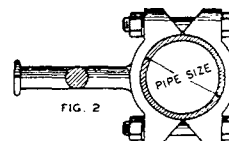

Extension Arm
Integral with Clamp

The TYPE DD clamp is installed on tubular bus and hot line clamp is attached to extended arm. Connections to transformers or ground connections can be easily made. Extension bolt can be adjusted so as to be either perpendicular or parallel to bus. Larger sizes can be supplied. Dimension prints furnished on request.

TYPE DE



Conductor Range	Catalog No.
#12-#6	9580
#10-#1	9581
# 6-1/0	9582
# 1-4/0	9583
1/0-350	9584

Example for ordering: - #9582 Royal Type DE Ground Clamp
#6-1/0 cable.

The TYPE DE is a multi-purpose ground clamp. It can be applied to steel columns, switch bases, equipment tanks, mine track or crane rail. Can be furnished for sizes not listed. Made of Bronze Alloy with Silicon Bronze Bolts. Drawings on request. Specify thickness of flat surface.

TYPE DF

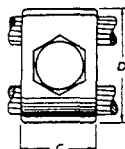

Cable Range		Cat. No.	Dim. in Inches		
A	B		C	D	S
2 - 4/0	2 - 4/0	1761	1 1/4	1 3/4	1/2
4/0 - 300 MCM	4/0 - 300 MCM	1763	1 1/2	2 5/8	1/2
350 - 500 MCM	350 - 500 MCM	1765	1 3/4	2 7/8	1/2
500 - 750 MCM	500 - 750 MCM	2175	2	3	1/2
800 - 1000 MCM	800 - 1000 MCM	2176	2 1/2	3	1/2
1000 - 1500 MCM	1000 - 1500 MCM	2177	2 1/2	3 1/2	5/8

Example for ordering: - #1765 Royal Type DF ground clamp
350-500 MCM cable range.

Bolt length for 1/4" thick flat bar will be furnished unless otherwise specified on order.

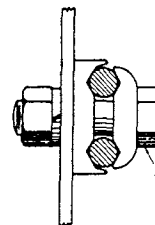

Gb-Ground Clamps

ROYAL SWITCHGEAR MANUFACTURING CO.

3995 Pine Lane SE • Bessemer, AL 35023 • (205) 426-4090 • FAX (205) 426-4095

Gb-2 POWER CONNECTORS

GROUND CLAMPS

TYPE DG

CABLE TO ROD OR PIPE

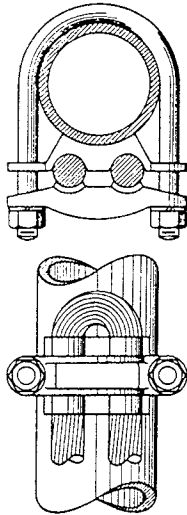

Catalog No.	Size Rod or Tube	SPS	Conductor Range	
			Min.	Max.
9588	5/8. 3/4	3/8	#6	2/0
9589	5/8. 3/4	3/8	#1	4/0
9590	5/8. 3/4	3/8		300
9591	1	1/2. 3/4	#1	4/0
9592	1	1/2. 3/4	1/0	300
9593	1	1/2. 3/4	300	500
9594	1 1/8. 1 1/4	1	#1	4/0
9595	1 1/8. 1 1/4	1	1/0	300
9596	1 1/8. 1 1/4	1	300	500
9597	1 1/8. 1 1/4	1	500	750
9598	1 1/8. 1 1/4	1	750	1000
9599		1 1/4	1/0	300
9600		1 1/4	300	500
9601		1 1/4	500	750
9602		1 1/4	750	1000
18315		1 1/2	1/0	300
18316		1 1/2	300	500
18317		1 1/2	500	750
18318		1 1/2	750	1000
18319		2	1/0	300
18320		2	300	500
18321		2	500	750
18322		2	750	1000
18323		2 1/2	1/0	300
18324		2 1/2	300	500
18325		2 1/2	500	750
18326		2 1/2	750	1000
18327		3	4/0	300
18328		3	300	500
18329		3	500	750
18330		3 1/2	4/0	300
18331		3 1/2	300	500
18332		3 1/2	500	750
18333		4	4/0	300
18334		4	300	500
18335		4	500	750

TYPE DG is an effective ground clamp for making connections to rod, pipe, fence posts and cable.

Can be furnished for any size pipe up to 5-1/2" outside diameters.

Dimension prints furnished on request.

Bronze Clamp with Silicon Bronze "U" Bolt.

Example for Ordering: - #9599 Royal Type DG Ground 1-1/4" Pipe to 1/0-300 MCM Cable.

TYPE DH

CABLE TO FLAT SURFACE

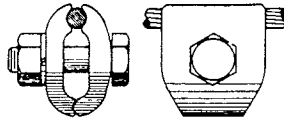

Catalog No.	Conductor Range
1993	#4 - 2/0
1994	2/0 - 250 MCM
1995	300 MCM - 500 MCM
1996	550 MCM - 750 MCM
1997	800 MCM - 1000 MCM

Type DH is designed for clamping cable to substation or tower steel, flat bar or metal clad gear. 1/2" diameter bolts for clamping to 1/4" thick bar furnished as standard.

Example for ordering: - #1995 Royal Type DH Ground Clamp 300-500 MCM cable.

TYPE DI

ROD OR PIPE TO CABLE

CABLE TO CABLE OR SOLID CONDUCTOR

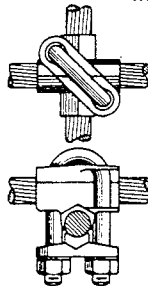

Catalog No.	Rod or Tube	SPS	Conductor Range	
			Min.	Max.
9565	5/8. 3/4	3/8	#6	2/0
9566	5/8. 3/4	3/8	#1	4/0
9567	5/8. 3/4	3/8	1/0	300
9568	1	1/2. 3/4	#1	4/0
9569	1	1/2. 3/4	1/0	300
9570	1	1/2. 3/4	300	500
9571	1 1/8. 1 1/4	1	#1	4/0
9572	1 1/8. 1 1/4	1	1/0	300
9573	1 1/8. 1 1/4	1	300	500
9574	1 1/8. 1 1/4	1	500	750
9575	1 1/8. 1 1/4	1	750	1000
9576		1 1/4	1/0	300
9577		1 1/4	300	500
9578		1 1/4	500	750
9579		1 1/4	750	1000

Designed to take any combination of rod, pipe, cable or solid conductor. Furnished in high strength, low resistance bronze alloy complete with Silicon Bronze "U" Bolts.

Dimension prints furnished on request.

Example for Ordering: - #9577 Royal Type DI Cross Ground Clamp 1-1/4" IPS to 300-500 MCM Cable.

ROYAL SWITCHGEAR MANUFACTURING CO.

3995 Pine Lane SE • Bessemer, AL 35023 • (205) 426-4090 • FAX (205) 426-4095

POWER CONNECTORS **Gb-3**

GROUND CLAMPS

TYPE DK

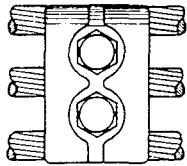

THREE CABLES OF EQUAL SIZE TO FLAT SURFACE

Catalog No.	Conductor Range	Bolt Size
9603	#8 . #4	3/8
9604	#4 . #2/0	3/8
9605	2/0 . 300	3/8
9606	350 . 500	1/2
9607	500 . 750	1/2
9608	750 . 1000	1/2

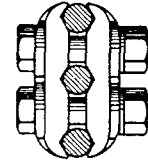

Example for Ordering: - #9605 Royal Type DK Parallel Ground Clamp 2/0-300 MCM Cable.

The Type DK is of Electrical Bronze with Silicon Bronze Bolts. Lips prevent bolt head from turning which permits ONE wrench installation. Dimension prints furnished on request.

TYPE DN

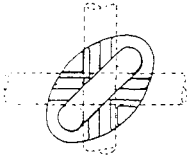

Catalog No.	Cable Range	
	Min.	Max.
9556	#8	2/0
9557	#1	4/0
9558	1/0	300
9559	300	500
9560	500	750
9561	750	1000

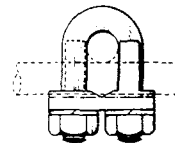

Example for Ordering: - #9560 Royal Type DN Cross Connector Ground Clamp 500-750 Cable Range.

TYPE DP

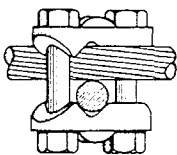

Catalog No.	Tube	Catalog No.	Cable Range
2134	1/4	2142	#8, #4
2135	3/8	2143	#4, 2/0
2136	1/2	2144	2/C, 250
2137	3/4	2145	300, 500
2138	1	2146	500, 750
2139	1 1/4	2147	1000, 1250
2140	1 1/2	2148	1250, 1500
2141	2	2149	1500, 2000

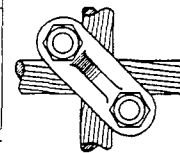

Example for Ordering: - #2144 Royal Type DP Cross Connector 2/0 to 250 MCM Cable.

The TYPE DP Cross Ground Clamp is an economical design for connecting tubing to tubing; cable to cable; tubing to cable.

Larger sizes available. Dimension prints furnished on request.

TYPE DR

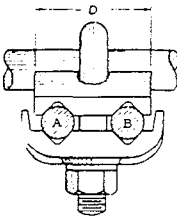

Cat. No.	Size Rod Pipe	Cable Range			Dim. in Inches		
		A	B	C	D	S	
1795	5/8, 3/4	2 . 4/0	2 . 4/0	2 1/2	1 3/8	3/8	
1797	1	2 . 4/0	2 . 4/0	2 1/2	1 3/8	3/8	
1799	1 1/4	2 . 4/0	2 . 4/0	2 3/4	1 1/2	3/8	
1801	5/8, 3/4	4/0 . 350 MCM	4/0 . 350 MCM	3 1/2	2 1/8	1/2	
1803	1	4/0 . 350 MCM	4/0 . 350 MCM	3 1/2	2 1/8	1/2	
1805	1 1/4	4/0 . 350 MCM	4/0 . 350 MCM	3 1/2	2 1/8	1/2	

Example for Ordering: - #1799 Royal Type DR Ground Clamp 1-1/4" IPS to 2/0 - 4/0 Cable.

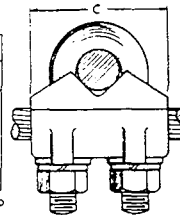

Gb-Ground Clamps

ROYAL SWITCHGEAR MANUFACTURING CO.

3995 Pine Lane SE • Bessemer, AL 35023 • (205) 426-4090 • FAX (205) 426-4095

Gb-4 POWER CONNECTORS

GROUND CLAMPS

TYPE DQ

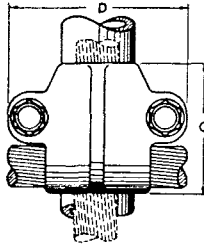

Cat. No.	Size		Cable Range	Dim. in Inches		
	Rod or Tube	SPS		C	D	S
2018	1/2	1/4	8 - 1	1 1/2	1	3/8
2019	1/2	1/4	0 - 4/0	1 1/2	1	3/8
2020	5/8-3/4	3/8	8 - 1	1 1/2	1	3/8
2021	5/8-3/4	3/8	0 - 4/0	1 1/2	1	3/8
2022	5/8-3/4	3/8	250 MCM - 500 MCM	2 1/4	1 1/4	1/2
2023	1	1/2-3/4	8 - 1	1 1/2	1 1/2	3/8
2024	1	1/2-3/4	0 - 4/0	2	1 1/2	3/8
2025	1	1/2-3/4	250 MCM - 500 MCM	2	1 5/8	1/2
2026	1	1/2-3/4	500 MCM - 1000 MCM	2 3/4	1 5/8	1/2
2027	1	1	8 - 1	1 1/2	1 3/4	3/8
2028	1	1	0 - 4/0	1 1/2	1 3/4	3/8
2029	1	1	250 MCM - 500 MCM	2	1 7/8	1/2
2030	1	1	500 MCM - 1000 MCM	2 3/4	1 7/8	1/2
18336	1 1/4	1 1/4	8 - 1	1 1/2	1 3/4	3/8
18337	1 1/4	1 1/4	0 - 4/0	1 1/2	1 3/4	3/8
18338	1 1/4	1 1/4	250 MCM - 500 MCM	2	1 7/8	1/2
18339	1 1/4	1 1/4	500 MCM - 1000 MCM	2 3/4	1 7/8	1/2
2031	1 1/2	1 1/2	8 - 1	1 1/2	2 1/4	3/8
2032	1 1/2	1 1/2	0 - 4/0	2	2 1/4	3/8
2033	1 1/2	1 1/2	250 MCM - 500 MCM	2	2 1/2	1/2
2034	1 1/2	1 1/2	500 MCM - 1000 MCM	3	2 1/2	1/2
2035	2	2	8 - 1	1 1/2	2 3/4	3/8
2036	2	2	0 - 4/0	2	2 3/4	3/8
2037	2	2	250 MCM - 500 MCM	2	3	1/2
2038	2	2	500 MCM - 1000 MCM	3	3	1/2
2039	3	3	8 - 1	1 1/2	4	3/8
2040	3	3	0 - 4/0	2	4	3/8
2041	3	3	250 MCM - 500 MCM	2	4 1/4	1/2
2042	3	3	500 MCM - 1000 MCM	3	4 1/4	1/2
2043	4	4	8 - 1	1 1/2	5	3/8
2044	4	4	0 - 4/0	2	5	3/8
2045	4	4	250 MCM - 500 MCM	2	5 1/8	1/2
2046	4	4	500 MCM - 1000 MCM	3	5 1/8	1/2

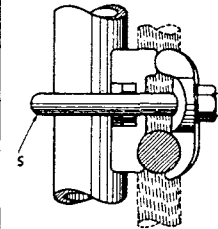

Clamp body is of standard ROYAL bronze. "U" Bolt is of Silicon Bronze. Dimension prints furnished on request.

Example for Ordering: - #2034 Royal Type DQ Ground Clamp 1-1/2" Pipe to 500-1000 MCM cable.

Type DQ will accommodate wide ranges of ground cable. Clamp may be installed after ground rod is driven. Silicon Bronze Bolts, nuts and lock washers furnished standard. Parallel or 90° connection to Rod, Tube or Pipe can be made with this ground clamp.

TYPE DS

CABLE TO ROD OR PIPE

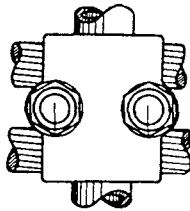

Catalog No.	Size		Conductor Range	
	Rod or Tube	SPS	Min.	Max.
9609	1/2	1/4	#5	2/0
9610	1/2	1/4	#1	4/0
9611	1/2	1/4	1/0	300
9612	5/8-3/4	3/8	#6	2/0
9613	5/8-3/4	3/8	#1	4/0
9614	5/8-3/4	3/8	1/0	300
9615	1	1/2-3/4	#1	4/0
9616	1	1/2-3/4	1/0	300
9617	1	1/2-3/4	300	500
9618	1 1/8-1 1/4	1	#1	4/0
9619	1 1/8-1 1/4	1	1/0	300
9620	1 1/8-1 1/4	1	300	500
9621	1 1/8-1 1/4	1	500	750
9622	1 1/8-1 1/4	1	750	1000
9623	1 1/4	1 1/4	1/0	300
9624	1 1/4	1 1/4	300	500
9625	1 1/4	1 1/4	500	750
9626	1 1/4	1 1/4	750	1000

Example for Ordering: - #9615 Royal Type DS Ground Clamp 1" Rod to #1 to 4/0 Cable.

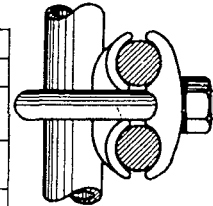

For Grounding two conductor to rod, pipe or fence posts. Can be furnished for any size ground rod or pipe up to 5-1/2" outside diameter.

ROYAL SWITCHGEAR MANUFACTURING CO.

3995 Pine Lane SE • Bessemer, AL 35023 • (205) 426-4090 • FAX (205) 426-4095

POWER CONNECTORS **Gb-5**

GROUND CLAMPS

TYPE DSH-1

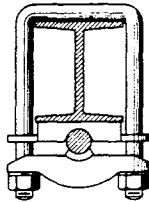

1 - CABLE TO H - SECTION POST

Size H-Post	Conductor Range		Catalog No.
	Min.	Max.	
1 5/8 x 1 7/8	#8	#4	10965
1 5/8 x 1 7/8	#4	2/0	10966
1 5/8 x 1 7/8	2/0	250	10967
2 x 2 1/4	#8	#4	10968
2 x 2 1/4	#4	2/0	10969
2 x 2 1/4	2/0	250	10970
2 x 2 1/4	300	500	10971

Example for ordering: 10969 Royal Type DSH-1 Ground Clamp for 2" x 2 1/4" H-Section post to 2/0 cable.

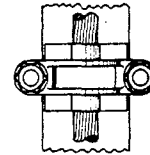

TYPE DSH-2

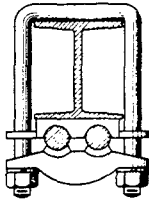

2-CABLES TO H-SECTION POST

Size H-Post	Conductor Range		Catalog No.
	Min.	Max.	
1 5/8 x 1 7/8	#8	#4	6741
1 5/8 x 1 7/8	#4	2/0	6742
1 5/8 x 1 7/8	2/0	250	6743
2 x 2 1/4	#8	#4	6744
2 x 2 1/4	#4	2/0	6745
2 x 2 1/4	2/0	250	6746
2 x 2 1/4	300	500	6747

Example for ordering: - #6744 Royal Type DSH-2 Ground Clamp for 2"x2 1/4" H Section Post to #4 Cable.

Designed to meet growing requirement for a clamp to ground two cable or a looped cable to H section.

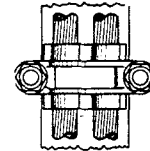

TYPE DSH-3

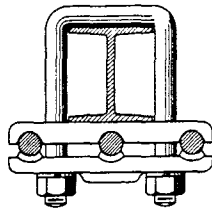

3-CABLES TO H-SECTION POST

Size H-Post	Conductor Range		Catalog No.
	Min.	Max.	
1 5/8 x 1 7/8	#8	#4	6748
1 5/8 x 1 7/8	#4	2/0	6749
1 5/8 x 1 7/8	2/0	250	6750
2 x 2 1/4	#8	#4	6751
2 x 2 1/4	#4	2/0	6752
2 x 2 1/4	2/0	250	6753
2 x 2 1/4	300	500	6754

Example for ordering: - #6753 Royal Type DSH-3 Ground Clamp for 2"x2 1/4" H Section Post to 4/0 Cables.

Designed to provide means for grounding 3 parallel cables to H Section fence posts.

Bolt is of Everdur or Duronze. Clamp body is high conductivity bronze. Clamps for other post sections and larger cables can be supplied.

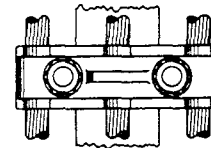

Gb-Ground Clamps

ROYAL SWITCHGEAR MANUFACTURING CO.

3995 Pine Lane SE • Bessemer, AL 35023 • (205) 426-4090 • FAX (205) 426-4095

Gb-6 POWER CONNECTORS

GROUND CLAMPS

TYPE DT

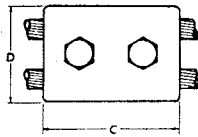

Cat. No.	Cable Range		Dim. in Inches				
	A	B	C	D	S		
2178	#2 - 4/0	#2 - 4/0	2	1 3/4	1/2		
2179	4/0 - 300 MCM	4/0 - 300 MCM	2 1/2	2 5/8	1/2		
2180	350 - 500 MCM	350 - 500 MCM	2 3/4	2 7/8	1/2		
2181	500 - 750 MCM	500 - 750 MCM	3	3	1/2		
2182	750 - 1000 MCM	750 - 1000 MCM	3 1/2	3	1/2		
2183	1000 - 1500 MCM	1000 - 1500 MCM	3 1/2	3 1/2	1/2		

Example for Ordering: - #2180 Royal Type DT Ground Clamp 350-500 MCM Cable Range.

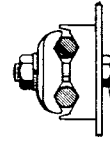

TYPE DU

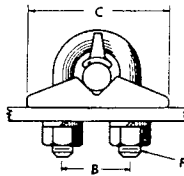

Catalog No.	Cable Range	Dimensions in Inches			
		B	C	D	F
1757	#8 - #4	1 3/16	2	1 1/8	3/8
1758	#4 - 1/0	1 3/16	2	1 1/8	3/8
1759	1/0 - 350	1 3/16	2 1/2	1 3/8	3/8
15267	350 - 500	1 5/8	2 3/4	1 1/2	1/2
15268	500 - 800	1 5/8	2 3/4	1 1/2	1/2
15269	800 - 1000	1 3/4	2 3/4	1 1/2	1/2

Example for Ordering: - #1758 Royal Type DU Ground Clamps #4-1/0 Cable Range.
U-bolt length for 1/4" thick flat bar will be furnished unless otherwise specified on order.

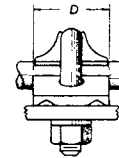

TYPE DW

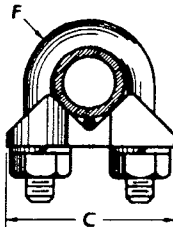

Size Rod	Wire Range	Cat. No.	Dim. in Inches		
			C	D	F
1/2	8 - 2	1777	1 3/4	1 1/4	3/8
5/8-3/4	8 - 2	1778	2	1 1/4	3/8
1	8 - 2	1779	2 1/4	1 1/4	3/8

Example for ordering: - #1778 Royal Type DW Ground Clamp 5/8"-3/4" Rod to #8-#2 Wire.

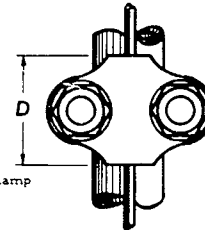

TYPE DZ

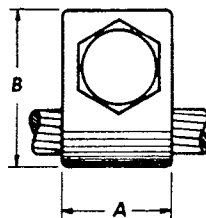

Catalog No.	Conductor Range	Dimensions in Inches		
		A	B	C
6755	#8 - #14	1 1/4	1 3/4	1/2
6756	#4 - 2/0	1 1/4	1 3/4	1/2
6757	2/0 - 250 MCM	1 1/4	1 3/4	1/2
6758	300 MCM - 500 MCM	1 1/4	2 1/8	1/2
6759	550 MCM - 750 MCM	1 1/2	2 3/4	1/2
6760	750 MCM - 1000 MCM	1 1/2	2 3/4	1/2

Example for Ordering: - #6757 Royal Type DZ Ground Clamp 4/0 Cable to 1/4" Flat Bar.

Type DZ is designed for clamping cable to steel structures, bus bar or metal clad switching equipment. 1/2" diameter clamping bolts furnished unless otherwise specified.

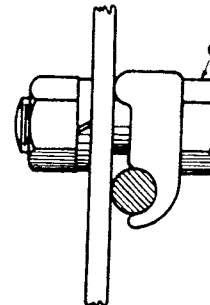

ROYAL SWITCHGEAR MANUFACTURING CO.

3995 Pine Lane SE • Bessemer, AL 35023 • (205) 426-4090 • FAX (205) 426-4095

POWER CONNECTORS **Gb-7**

TERMINAL LUG

TYPE DMG

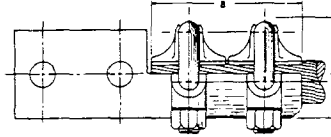

Fig. 1

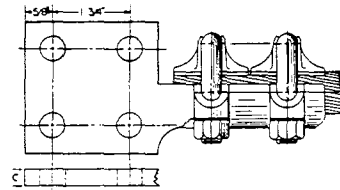

Fig. 2

Catalog No.	Conductor Range		Pad (Inches)	Fig. No.	Max. Dimensions, Inches			Bolt Size
	Min.	Max.			A	B	C	
17989	#6 SOL.	2/0 STR.	2 x 3	1	2 1/16	2 1/2	1/4	3/8
17990	#1 SOL.	4/0 STR.	2 x 3	1	2 1/4	2 1/2	1/4	3/8
17991	1/0 SOL.	300 MCM	2 x 3	1	2 3/8	3	1/4	3/8
17992	1/0 SOL.	300 MCM	3 x 3	2	2 3/8	3	1/4	3/8
17993	300 MCM	500 MCM	2 x 3	1	3	3	3/8	1/2
17994	300 MCM	500 MCM	3 x 3	2	3	3	3/8	1/2
17995	500 MCM	800 MCM	2 x 3	1	3 1/16	3 1/2	1/2	1/2
17996	500 MCM	800 MCM	3 x 3	2	3 1/16	3 1/2	3/8	1/2
17997	750 MCM	1000 MCM	2 x 3	1	3 3/8	4	1/2	1/2
17998	750 MCM	1000 MCM	3 x 3	2	3 3/8	4	3/8	1/2
17999	1000 MCM	1500 MCM	3 x 3	2	3 5/8	4	1/2	1/2
18000	1000 MCM	1500 MCM	4 x 4	2	3 5/8	4	1/2	1/2
18001	1500 MCM	2000 MCM	3 x 3	2	3 7/8	4	1/2	1/2
18002	1500 MCM	2000 MCM	4 x 4	2	3 7/8	4	1/2	1/2

Example for Ordering: - #17992 Royal Type DMG Terminal Lug 1/0 Sol. to 300 MCM Fig. 2.

Cable Clamp is offset to obtain bolt clearance when flat contact surface extends beyond pad.

Independent keepers assembled captive on "U" bolts provide highest contact pressure.

Gb-Ground Clamps

ROYAL SWITCHGEAR MANUFACTURING CO.

3995 Pine Lane SE • Bessemer, AL 35023 • (205) 426-4090 • FAX (205) 426-4095

TYPE PRB

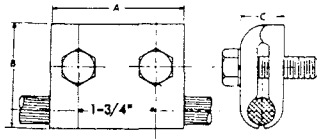

Catalog No.	Cable Range	Dimensions in Inches		
		A	B	C-Max.
16080	1/0 - 300 MCM	3	2 1/4	1 7/16

Example for Ordering: - #16080 Royal Type PRB Ground Clamp 1/0-300 MCM.

TYPE PSB

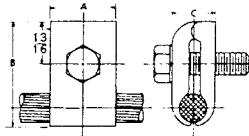

Catalog No.	Cable Range	Dimensions in Inches		
		A	B	C-Max.
16081	1/0 - 300 MCM	1 1/2	2 1/16	1 7/16

Example for Ordering: - #16081 Royal Type PSB Ground Clamp 1/0-300 MCM.

Type PRB and PSB were designed to meet the requirements of modern equipment grounding practice. Type PRB, with 1-3/4" bolt centers, will mount on the 2" x 3" grounding pad now standard on most Transformers, Oil Circuit Breakers, Coupling Capacitors. Contact surfaces silver plated to specifications.

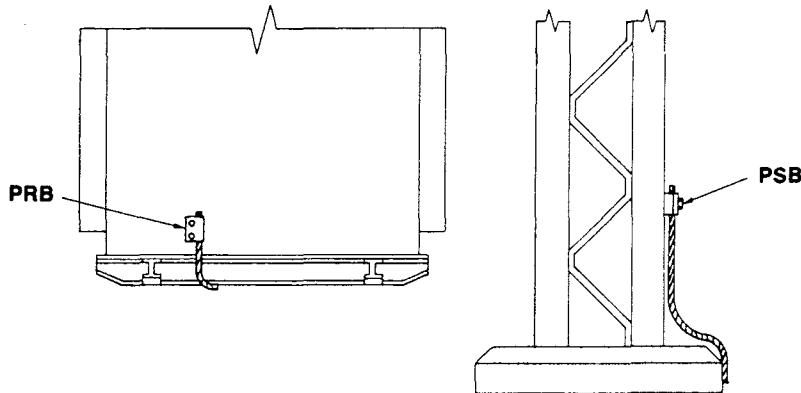

ROYAL SWITCHGEAR MANUFACTURING CO.

3995 Pine Lane SE • Bessemer, AL 35023 • (205) 426-4090 • FAX (205) 426-4095